

MINO 60 system

ceiling/ suspended

EN Luminaire housing from extruded aluminium profile, angular design; no visible screws; for lighting systems; powder coated; luminaire profile for mounting available in advance; remaining components mounted without tools; pendant fitting with cable suspension; height adjustment without tools; spring clip attachment to the luminaire; with transparent feeder cable; light inset consisting of highly reflective coated extruded profile for improved thermal management; option: lighting module is versatile in length; HPO (High Performance Opal) cover for uniform illumination; micro prismatic PMMA diffuser incl. diffuser film for homogeneous illumination and reduced luminance; wallwasher light inset; energy-eff. LEDs – very good colour rendering

DE Leuchtenkörper aus Aluminiumstrangpressprofil, kantige Ausführung; keine sichtbaren Schrauben; für Lichtsysteme; pulverbeschichtet; Leuchtenprofil für Montage vorab lieferbar; restl. Komponenten werkzeuglos montierbar; abgependelt mit Seilabhängung; werkzeuglose Höhenverstellung; Federclips-Befestigung an der Leuchte; inkl. transp. Einspeiseleitung; Lichteinsatz bestehend aus hochreflektierend lackiertem Strangpressprofil für verbessertes Thermomanagement; optional flexibel ablängbarer Lichteinsatz; HPO (High Performance Opal) Abdeckung für homogene Ausleuchtung; mikroprismatische PMMA-Abdeckung inkl. Diffusorfolie zur Reduktion der Leuchtdichte bei homogener Ausleuchtung; Wallwasher Lichteinsatz; energieeff. LEDs – sehr gute Farbwiedergabe

Quickinfo

3000 K, 4000 K, TW
 CRI ≥ 80, CRI ≥ 90, 3 SDCM
 up to 2760 lm/m
 up to 125 lm/W
 L90 @ 50 000 h
 non DIM, DALI-2
 opal, microprismatic (UGR ≤ 19)

Types

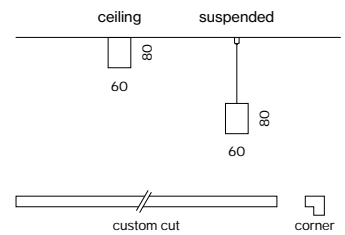

Colours



Light distributions



DiiA® standards
 251, 252, 253



single luminaire
 (p. 544)



wallwasher
 inset (p. 944)

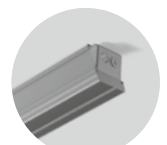

concrete install.
 housing (p. 946)



flexible
 inset

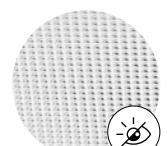

microprismatic
 UGR ≤ 19

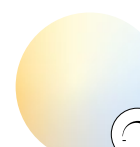

tunable white
 2700–6500 K

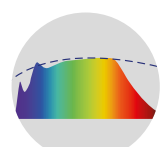

CRI ≥ 98
 XPECTRUM

Order options

LED TYPE	
mid lumen	L
high lumen	M

COLOUR TEMPERATURE	
3000 K (CRI \geq 90)	0
4000 K (CRI \geq 90)	1
3000 K (CRI \geq 80)	5
4000 K (CRI \geq 80)	6
tunable white 2700–6500 K*	

*DALI-2 DT8

CONTROL	
non DIM	1
DALI-2 (only high lumen)	3

MATERIAL COLOUR	
pure white RAL 9010	7
white aluminium RAL 9006	G
jet black RAL 9005	8
special colours p.992	X

LIGHT OPTIC COVER	
opal high performance	H
microprismatic	Z
microprismatic (UGR \leq 19)*	G
blind cover only for corner 90°	B

*UGR \leq 19 only with mid lumen

EMERGENCY LIGHT	
1h Accupack	N L 1
3h Accupack	N L 3

Options on request

COLOUR RENDERING INDEX
CRI \geq 98 XPECTRUM

CONNECTORS
X- and T-connector

LUMINOUS FLUX value calculated for
CRI \geq 80, colour white, cover opal
microprismatic -13%

MINO 60 ceiling/suspended

INSTALLATION CHANNEL / CORNER 90°

TYPE	L (mm)	ORDER CODE
channel	1172	046-400401
channel	1472	046-400501
channel	3000	046-400901
channel	custom	E85031 ····
channel corner 90° + cover	150x150	046-401121

LIGHT OPTIC COVER/BLIND COVER

TYPE	L (mm)	ORDER CODE
linear	1171	006-16122
linear	1470	006-16152
linear	2997	006-16302
linear	custom	E80630 ···· 0
continuous linear	6000	006-23061H
continuous linear	25000	006-23251H
blind cover	3000	006-1830
blind cover	custom	E80630 ····

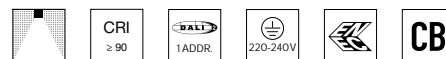

LIGHT INSET 60

SYSTEM POWER (MID/HIGH LUMEN)	L (mm)	ORDER CODE
8.7 / 13.8 W	571	007-93 2 7
13 / 20.6 W	871	007-93 3 7
15.3 / 27.5 W	1171	007-93 4 7
19.2 / 34 W	1463	007-93 5 7
31 / 55 W	2341	007-93 8 7
38 / 68 W	2997	007-93 9 7
15.3 / 27.5 W flex	660-1171	007-93 F 7
31 / 55 W flex	1903-2341	007-93 G 7

COVER	COLOUR TEMP.	SYSTEM POWER	DELIVERED LUMENS	EFFICACY
mid lumen / opal	3000 K	14 W/m	1540 lm/m	118 lm/W
high performance	4000 K		1640 lm/m	125 lm/W
high lumen / opal	3000 K	24 W/m	2540 lm/m	110 lm/W
high performance	4000 K		2700 lm/m	116 lm/W

LIGHT INSET 60 tunable white 2700–6500 K

SYSTEM POWER	L (mm)	ORDER CODE
21.7 W	871	007-9333D37
29 W	1171	007-9334D37
36 W	1463	007-9335D37
58 W	2341	007-9338D37

Accessories

END CAPS

TYPE	ORDER CODE
end caps (pair)	046-501001

LINEAR CONNECTOR/THROUGH WIRE

TYPE	ORDER CODE
linear connector (1 piece)	005-40046
linear connector (10 pieces)	005-40046.10
opal cover linear connector	006-14000
through wire 3 × 1.5 mm ² (non DIM, 10 pieces)	004-90003
through wire 5 × 1.5 mm ² (DALI-2, 10 pieces)	004-90005

CEILING CLIP / CABLE SUSPENSION / CANOPY

TYPE	L (mm)	ORDER CODE
ceiling clip	10	034-111636
cable suspension	1500	005-2122110
canopy / feeder cable 3 × 1.5 mm ²	1500	005-221231
canopy / feeder cable 5 × 1.5 mm ²	1500	005-221241
cable rail	1200	005-2491110

for electrical system configuration see luminaire data sheet at xal.com

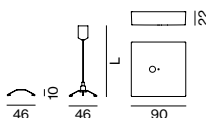
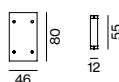
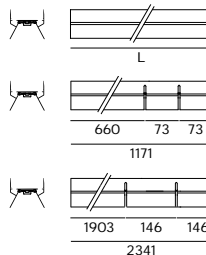



WALLWASHER

inset 60/100

EN Lighting module with specially computed, asymmetrical high gloss reflector for homogeneous vertical lighting; lighting module in aluminium, powder coated, installation without tools

DE Lichteinsatz mit speziell berechnetem, asymmetrischem Hochglanz-Reflektor für homogene vertikale Beleuchtungen; Lichteinsatz aus pulverbeschichtetem Aluminium werkzeuglos einsetzbar

Quickinfo

3000K, 4000K
CRI ≥ 80, 3 SDCM
up to 96lm/W
L80 @ 50000h
non DIM, DALI-2

Types

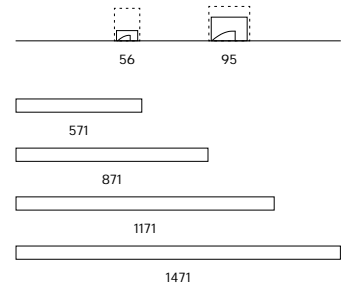

Colours



Light distribution



wall
washer

Order options

COLOUR TEMPERATURE	
3000K	5
4000K	6

CONTROL	
non DIM	1
DALI-2	3

MATERIAL COLOUR	
○ pure white RAL 9010	7
● white aluminium RAL 9006	G
● jet black RAL 9005	8

LIGHT OPTIC

wallwasher

Planning information

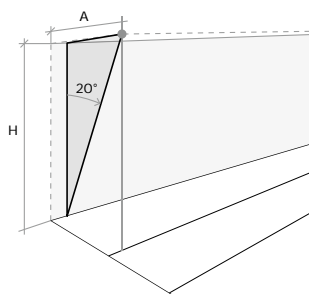

MOUNTING DISTANCE

H (mm)	A (mm)
2750	900
3000	1000
3500	1200

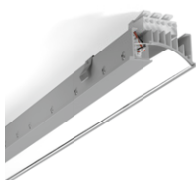

INSET 60 wallwasher



LIGHT INSET only for recessed or surface mounting

SYSTEM POWER	L (mm)	ORDER CODE
10.6 W	571	007-9042
14 W	871	007-9043
18.7 W	1171	007-9044
28 W	1471	007-9045

Technical data

SYSTEM POWER	COLOUR TEMPERATURE	DELIVERED LUMENS	EFFICACY
17 W/m	3000 K	1960 lm/m	121 lm/W
	4000 K	2070 lm/m	128 lm/W

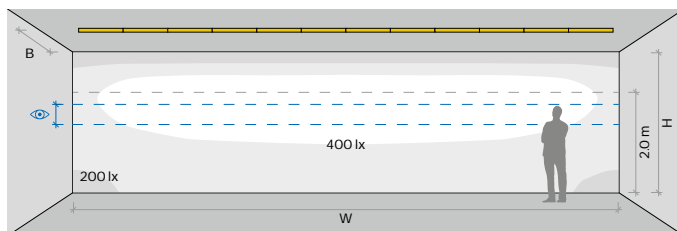

INSET 60 wallwasher, 18.7 W, 3000 K

ROOM VALUES

Wall dimensions	H = 2.8 m W = 10.8 m
Distance to wall	B = 1.3 m
Distance between luminaires	continuous
Reflection factor	0.7 0.5 0.2
Maintenance factor	0.8

CALCULATION SURFACE

Surface dimensions	10.8 × 2.8 m
Surface height	0 – 2.8 m
Eye level	1.35 m – 1.75 m

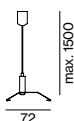
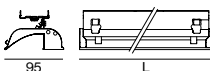

INSET 100 wallwasher



LIGHT INSET

SYSTEM POWER	L (mm)	ORDER CODE
20 W	571	007-9052
30 W	871	007-9053
40 W	1171	007-9054
51 W	1463	007-9055

CABLE SUSPENSION

TYPE	L (mm)	ORDER CODE
inset 100 wallwasher	1500	005-2132310

installation channel is required for mounting

Technical data

SYSTEM POWER	COLOUR TEMPERATURE	DELIVERED LUMENS	EFFICACY
35 W/m	3000 K	2820 lm/m	82 lm/W
	4000 K	2990 lm/m	87 lm/W

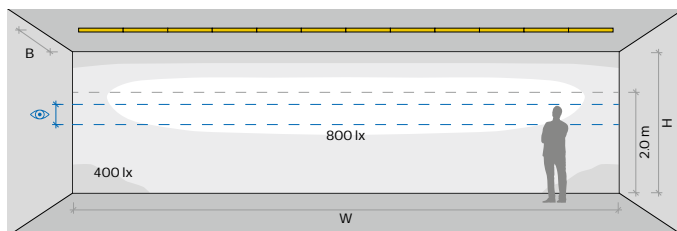

INSET 100 wallwasher, 30 W, 3000 K

ROOM VALUES

Wall dimensions	H = 2.8 m W = 10.8 m
Distance to wall	B = 1.3 m
Distance between luminaires	continuous
Reflection factor	0.7 0.5 0.2
Maintenance factor	0.8

CALCULATION SURFACE

Surface dimensions	10.8 × 2.8 m
Surface height	0 – 2.8 m
Eye level	1.35 m – 1.75 m

Light distribution

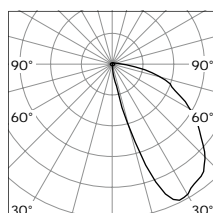

asymmetric

LUMINOUS FLUX value calculated for CRI ≥ 80, colour white, reflector chrome

Order options

NUMBER OF PIECES	
2 pieces	2
3 pieces	3

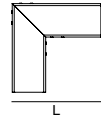
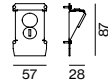
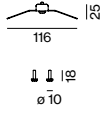

FRAME 40/MINO 40

HOUSING FOR CONCRETE INSTALLATION

TYPE	L (mm)	ORDER CODE
FRAME 40 trim	3010	005-41356
MINO 40	3010	005-41356

MOUNTING SET

TYPE	ORDER CODE
FRAME 40 trim	035-0602
MINO 40	034-0602

up to 900 mm: 2 pieces / up to 1500 mm: 3 pieces / up to 3000 mm: 2 x 2 pieces

END CAPS

TYPE	ORDER CODE
end caps (pair)	005-41236

LINEAR CONNECTOR

TYPE	ORDER CODE
linear connector (1 piece)	005-41166
linear connector (10 pieces)	005-41166.10

CORNER CONNECTOR 90°

TYPE	L (mm)	ORDER CODE
FRAME 40 trim	140	035-06016
MINO 40	140	035-06016

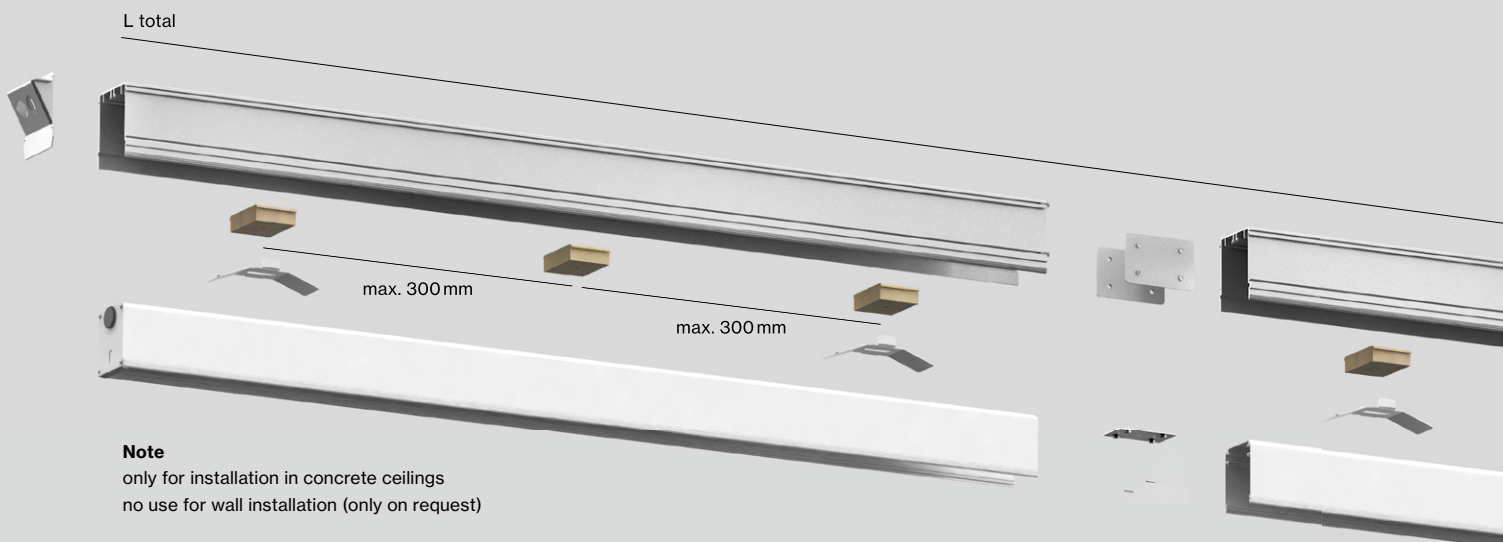

Note
only for installation in concrete ceilings
no use for wall installation (only on request)

CONCRETE installation housing

EN Concrete casting made of aluminium profile, designed for continuous lighting systems

DE Betoneingießgehäuse aus Aluminiumprofil, ausgelegt für durchgehende Lichtsysteme

Order options

NUMBER OF PIECES	
2 pieces	2
3 pieces	3

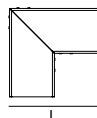
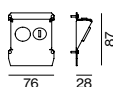
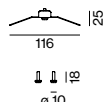

FRAME 60/MINIMAL 60/MINO 60/BASO 60

HOUSING FOR CONCRETE INSTALLATION

TYPE	L (mm)	ORDER CODE
FRAME 60 trim	3000	005-41346
BASO 60 IP54 trim	3000	005-41346
MINIMAL 60 trimless	3000	005-41346
MINO 60 ceiling	3000	005-41446
BASO 60 IP54 surface	3000	005-41446

MOUNTING SET

TYPE	ORDER CODE
FRAME 60 trim	035-0600
BASO 60 IP54 trim	035-0600
MINIMAL 60 trimless	036-0400
MINO 60 ceiling	034-0400
BASO 60 IP54 surface	034-0400

up to 900mm: 2 pieces/up to 1500mm: 3 pieces/up to 3000mm: 2x2 pieces

END CAPS

TYPE	ORDER CODE
end caps (pair)	005-41246

LINEAR CONNECTOR

TYPE	ORDER CODE
linear connector (1 piece)	005-41166
linear connector (10 pieces)	005-41166.10

CORNER CONNECTOR 90°

TYPE	L (mm)	ORDER CODE
FRAME 60 trim	142	035-04016
BASO 60 IP54 trim	142	035-04016
MINIMAL 60 trimless	146	036-04016
MINO 60 ceiling	157	034-04016
BASO 60 IP54 surface	157	034-04016

FRAME 100/MINIMAL 100/MINO 100

HOUSING FOR CONCRETE INSTALLATION

TYPE	L (mm)	ORDER CODE
FRAME 100 trim	3000	005-41366
MINIMAL 100 trimless	3000	005-41366
MINO 100 ceiling	3000	005-41466

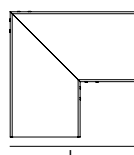
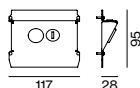
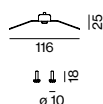

MOUNTING SET

TYPE	ORDER CODE
FRAME 100 trim	035-0600
MINIMAL 100 trimless	036-0500
MINO 100 ceiling	034-0400

up to 900mm: 2 pieces/up to 1500mm: 3 pieces/up to 3000mm: 2x2 pieces

END CAPS

TYPE	ORDER CODE
end caps (pair)	005-41266

LINEAR CONNECTOR

TYPE	ORDER CODE
linear connector (1 piece)	005-41166
linear connector (10 pieces)	005-41166.10

CORNER CONNECTOR 90°

TYPE	L (mm)	ORDER CODE
FRAME 100 trim	202	035-05016
MINIMAL 100 trimless	207	036-05016
MINO 100 ceiling	207	034-05016

Order options

COLOUR TEMPERATURE	
3000K	5
4000K	6

CONTROL	
non DIM	1
DALI-2	3

MATERIAL COLOUR	
○ pure white RAL 9010	7
● white aluminium RAL 9006	G
● jet black RAL 9005	8

LIGHT OPTIC

wallwasher

Planning information

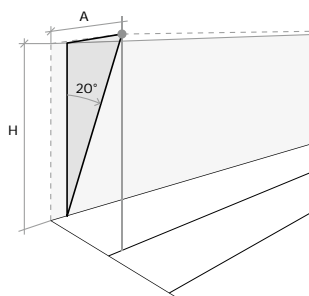

MOUNTING DISTANCE

H (mm)	A (mm)
2750	900
3000	1000
3500	1200



INSET 60 wallwasher



LIGHT INSET only for recessed or surface mounting

SYSTEM POWER	L (mm)	ORDER CODE
10.6 W	571	007-9042
14 W	871	007-9043
18.7 W	1171	007-9044
28 W	1471	007-9045

Technical data

SYSTEM POWER	COLOUR TEMPERATURE	DELIVERED LUMENS	EFFICACY
17 W/m	3000 K	1960 lm/m	121 lm/W
	4000 K	2070 lm/m	128 lm/W

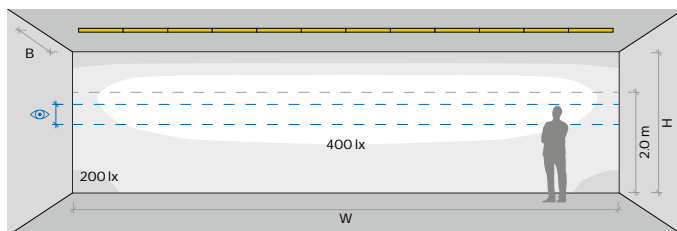

INSET 60 wallwasher, 18.7 W, 3000 K

ROOM VALUES

Wall dimensions	H = 2.8 m W = 10.8 m
Distance to wall	B = 1.3 m
Distance between luminaires	continuous
Reflection factor	0.7 0.5 0.2
Maintenance factor	0.8

CALCULATION SURFACE

Surface dimensions	10.8 × 2.8 m
Surface height	0 – 2.8 m
Eye level	1.35 m – 1.75 m

INSET 100 wallwasher



LIGHT INSET

SYSTEM POWER	L (mm)	ORDER CODE
20 W	571	007-9052
30 W	871	007-9053
40 W	1171	007-9054
51 W	1463	007-9055

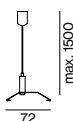
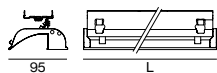

CABLE SUSPENSION

TYPE	L (mm)	ORDER CODE
inset 100 wallwasher	1500	005-2132310

installation channel is required for mounting

Technical data

SYSTEM POWER	COLOUR TEMPERATURE	DELIVERED LUMENS	EFFICACY
35 W/m	3000 K	2820 lm/m	82 lm/W
	4000 K	2990 lm/m	87 lm/W

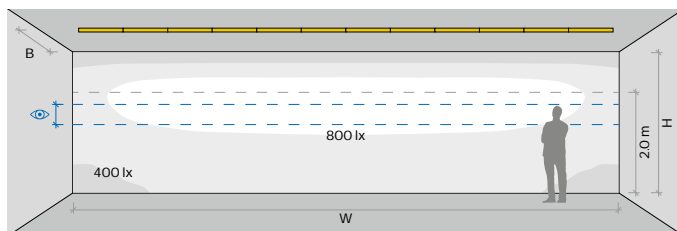

INSET 100 wallwasher, 30 W, 3000 K

ROOM VALUES

Wall dimensions	H = 2.8 m W = 10.8 m
Distance to wall	B = 1.3 m
Distance between luminaires	continuous
Reflection factor	0.7 0.5 0.2
Maintenance factor	0.8

CALCULATION SURFACE

Surface dimensions	10.8 × 2.8 m
Surface height	0 – 2.8 m
Eye level	1.35 m – 1.75 m

Light distribution

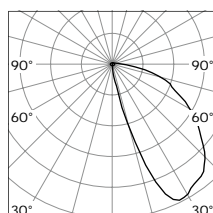

asymmetric

LUMINOUS FLUX value calculated for CRI ≥ 80, colour white, reflector chrome

Order options

NUMBER OF PIECES	
2 pieces	2
3 pieces	3

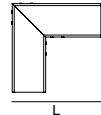
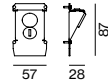
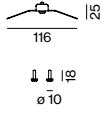



FRAME 40/MINO 40

HOUSING FOR CONCRETE INSTALLATION

TYPE	L (mm)	ORDER CODE
FRAME 40 trim	3010	005-41356
MINO 40	3010	005-41356

MOUNTING SET

TYPE	ORDER CODE
FRAME 40 trim	035-0602 
MINO 40	034-0602 

up to 900 mm: 2 pieces / up to 1500 mm: 3 pieces / up to 3000 mm: 2 x 2 pieces

END CAPS

TYPE	ORDER CODE
end caps (pair)	005-41236

LINEAR CONNECTOR

TYPE	ORDER CODE
linear connector (1 piece)	005-41166
linear connector (10 pieces)	005-41166.10

CORNER CONNECTOR 90°

TYPE	L (mm)	ORDER CODE
FRAME 40 trim	140	035-06016
MINO 40	140	035-06016

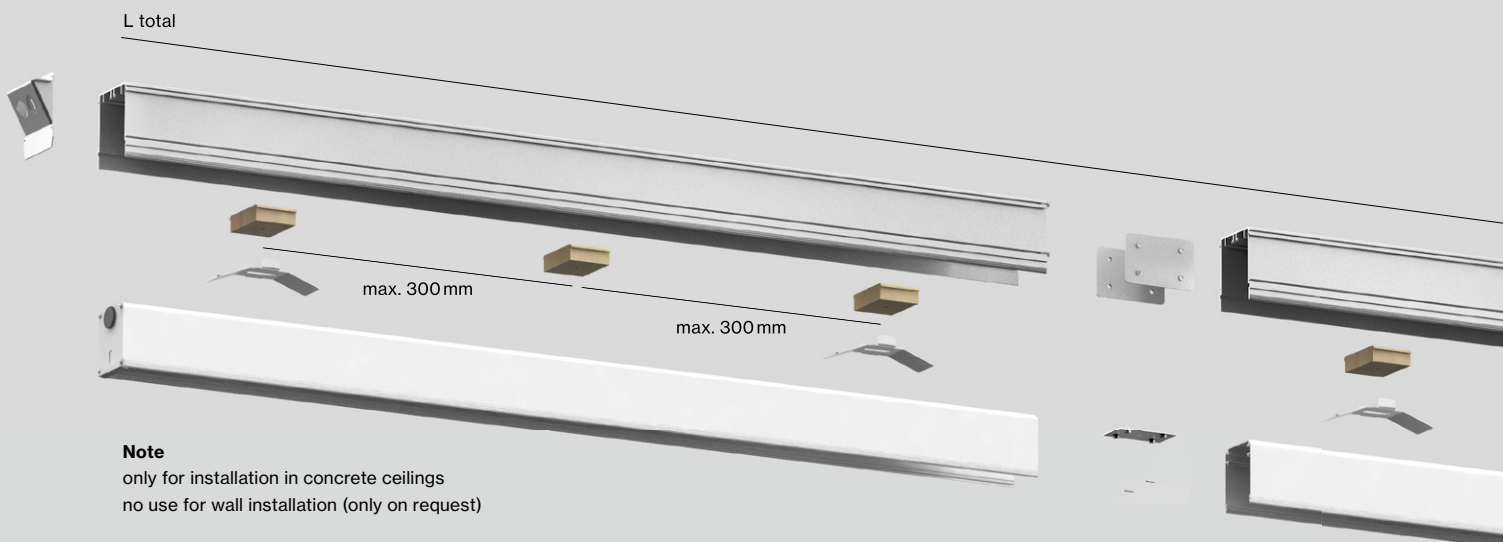

Note
only for installation in concrete ceilings
no use for wall installation (only on request)

CONCRETE installation housing

EN Concrete casting made of aluminium profile, designed for continuous lighting systems

DE Betoneingießgehäuse aus Aluminiumprofil, ausgelegt für durchgehende Lichtsysteme

Order options

NUMBER OF PIECES	
2 pieces	2
3 pieces	3

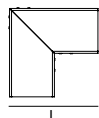
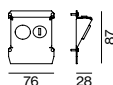
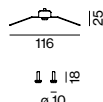

FRAME 60/MINIMAL 60/MINO 60/BASO 60

HOUSING FOR CONCRETE INSTALLATION

TYPE	L (mm)	ORDER CODE
FRAME 60 trim	3000	005-41346
BASO 60 IP54 trim	3000	005-41346
MINIMAL 60 trimless	3000	005-41346
MINO 60 ceiling	3000	005-41446
BASO 60 IP54 surface	3000	005-41446

MOUNTING SET

TYPE	ORDER CODE
FRAME 60 trim	035-0600
BASO 60 IP54 trim	035-0600
MINIMAL 60 trimless	036-0400
MINO 60 ceiling	034-0400
BASO 60 IP54 surface	034-0400

up to 900mm: 2 pieces/up to 1500mm: 3 pieces/up to 3000mm: 2x2 pieces

END CAPS

TYPE	ORDER CODE
end caps (pair)	005-41246

LINEAR CONNECTOR

TYPE	ORDER CODE
linear connector (1 piece)	005-41166
linear connector (10 pieces)	005-41166.10

CORNER CONNECTOR 90°

TYPE	L (mm)	ORDER CODE
FRAME 60 trim	142	035-04016
BASO 60 IP54 trim	142	035-04016
MINIMAL 60 trimless	146	036-04016
MINO 60 ceiling	157	034-04016
BASO 60 IP54 surface	157	034-04016

FRAME 100/MINIMAL 100/MINO 100

HOUSING FOR CONCRETE INSTALLATION



TYPE	L (mm)	ORDER CODE
FRAME 100 trim	3000	005-41366
MINIMAL 100 trimless	3000	005-41366
MINO 100 ceiling	3000	005-41466

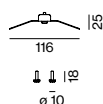

MOUNTING SET

TYPE	ORDER CODE
FRAME 100 trim	035-0600
MINIMAL 100 trimless	036-0500
MINO 100 ceiling	034-0400

up to 900mm: 2 pieces/up to 1500mm: 3 pieces/up to 3000mm: 2x2 pieces

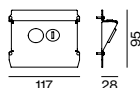

END CAPS

TYPE	ORDER CODE
end caps (pair)	005-41266



LINEAR CONNECTOR

TYPE	ORDER CODE
linear connector (1 piece)	005-41166
linear connector (10 pieces)	005-41166.10

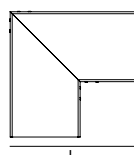

CORNER CONNECTOR 90°

TYPE	L (mm)	ORDER CODE
FRAME 100 trim	202	035-05016
MINIMAL 100 trimless	207	036-05016
MINO 100 ceiling	207	034-05016