



VARO 110 S

track

EN Track light made of die-cast aluminium; surface powder coated; spotlight head 355° rotatable and 90° tiltable; integrated converter in the plastic adapter; high quality reflector with spherical facet finish; precise radiation characteristics with different beam angles; installed and exchanged without tools; optical attachments as accessories; optical attachments can be combined; COB (Chip on Board) technology for maximum efficiency; variants with > 120 lm/W available; no multiple shadows; energy-efficient LEDs with very good colour rendering; adapter for toolless insertion or movement on a variety of 3-phase power tracks

FR Spot sur rail en fonte d'aluminium injectée ; surface thermolaquée ; tête de spot rotatif à 355° et orientable à 90° ; convertisseur intégré à l'adaptateur plastique ; réflecteur de grande qualité avec optique facette sphérique ; précision de caractéristique de rayonnement avec divers angles de diffusion ; Installation resp. remplacement sans outil ; éléments optiques comme accessoires ; les accessoires optiques peuvent être combinés entre eux ; avec technologie COB (Chip on Board) pour efficacité maximale ; variantes disponibles avec > 120 lm/W ; pas de formation d'ombres multiples ; LED économes en énergie à restitution de couleur élevée ; adaptateur pour installation ou déplacement sans outil dans différents rails trip hasés

Quickinfo

3000K, 3500K, 4000K
CRI ≥ 90, 3 SDCM
up to 132lm/W
L95/50 000h
non DIM, DALI-2

Type

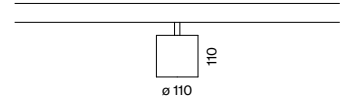

Colours



Light distributions



up to 132 lm/W
(high efficiency)



355° rotatable
90° tiltable

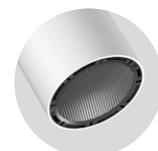

optical
accessories



combine 2 optical
accessories

Order options

COLOUR TEMPERATURE

| | |
|-------|---|
| 3000K | 0 |
| 3500K | 2 |
| 4000K | 1 |

CONTROL

| | |
|---------|---|
| non DIM | 1 |
| DALI-2 | 3 |

MATERIAL COLOUR

| | |
|--------------------------|---|
| ○ traffic white RAL 9016 | 7 |
| ● jet black RAL 9005 | 8 |

BEAM ANGLE

| | |
|----------------|---|
| spot 17° | S |
| medium 28° | M |
| flood 38° | F |
| wide flood 65° | W |

Options on request

LUMINOUS FLUX

>5000lm

CONTROL

Casambi

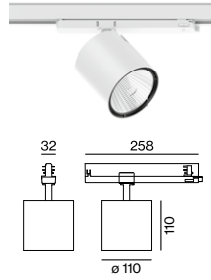

VARO 110 S track



HIGH EFFICIENCY

| SYSTEM POWER | LUMINOUS FLUX | ORDER CODE |
|--------------|---------------|------------|
| 25.7W | 3400lm | 180-6530 |
| 36W | 4520lm | 180-6531 |

Optical accessories

LENSES AND HONEYCOUMB LOUVER

| TYPE | Ø-H (mm) | ORDER CODE |
|------------------|----------|--------------|
| oval lens | 106-9 | 080-6502210 |
| wide flood lens | 106-9 | 080-6502110W |
| honeycomb louver | 106-9 | 080-6501118 |

SNOOT

| TYPE | Ø-H (mm) | ORDER CODE |
|--------|----------|-------------|
| short | 97-23 | 080-6503118 |
| medium | 97-38 | 080-6503218 |
| angle | 97-38 | 080-6503318 |



possibility to combine different optical accessories (max. 2 pieces)



Types

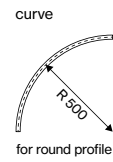
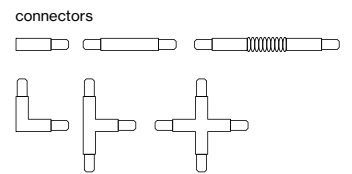
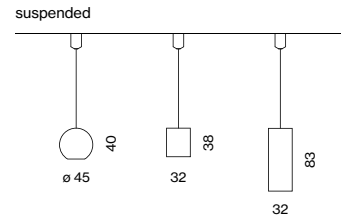
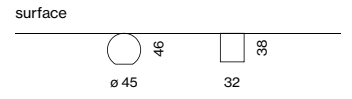
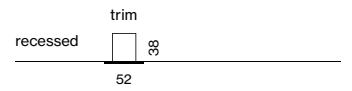

Colours



TRACK 3-phase

recessed/surface/suspended



curve connector



optimised adapter integration

TRACK recessed

Order options

CONTROL

non DIM

DALI-2

MATERIAL COLOUR

- pure white RAL 9010 7
- jet black RAL 9005 8

Pole options

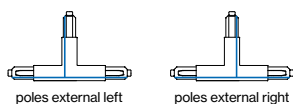
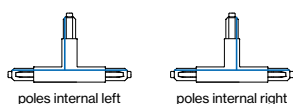

TRACK 3-phase/3-phase + DALI-2-bus



TRACK 240V-16A

| L (mm) | ORDER CODE |
|--------|------------|
| 2000 | 186-012213 |
| 3000 | 186-012313 |
| 4000 | 186-012413 |

end cap 186-022011

end feed left 186-022313
 end feed right 186-022413
 middle feed 186-021323

CONNECTORS 240V-16A

TYPE **ORDER CODE**
 linear connector 186-021113

I-connector 186-022123

L-connector right 186-022133
 L-connector left 186-022233

T-connector right (poles internal) 186-022143
 T-connector left (poles internal) 186-022243
 T-connector right (poles external) 186-022173
 T-connector left (poles external) 186-022273

X-connector 186-022153

MOUNTING ACCESSORIES

TYPE **ORDER CODE**
 clip 186-0225110

cutting tool 186-0219110

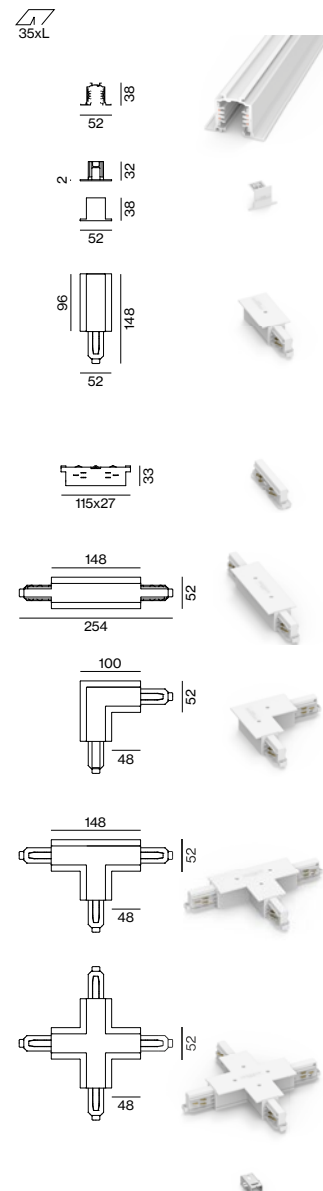

TRACK

surface/suspended

Order options

CONTROL

non DIM
 DALI-2

MATERIAL COLOUR

- pure white RAL 9010 7
- grey 6
- jet black RAL 9005 8

Pole options

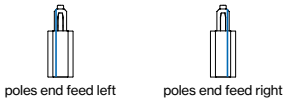
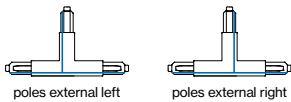
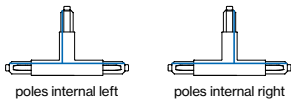

TRACK 3-phase/3-phase + DALI-2-bus



TRACK 240V-16A

| L (mm) | ORDER CODE |
|--------|------------|
| 1000 | 186-011123 |
| 2000 | 186-011223 |
| 3000 | 186-011323 |
| 4000 | 186-011423 |

end cap 186-021011

end feed left 186-021313
 end feed right 186-021413
 middle feed* 186-021323

*only available in white and black

CONNECTORS 240V-16A

TYPE ORDER CODE
 linear connector 186-021113

I-connector 186-021123

L-connector right 186-021133

L-connector left 186-021233

T-connector right (poles internal) 186-021143

T-connector left (poles internal) 186-021243

T-connector right (poles external) 186-021173

T-connector left (poles external) 186-021273

X-connector 186-021153

adjustable corner connector 186-021163

MOUNTING ACCESSORIES

TYPE ORDER CODE
 ceiling clip 186-021511

pendant clip cable 186-021521

pendant clip rod 186-021541

joiner piece cable 186-021531

joiner piece rod 186-021551

cutting tool 186-0219110

SUSPENSION KIT

TYPE ORDER CODE
 pendant 1000 186-021611

cable 1500 186-0217110

cable 3000 186-0217210

cable 5000 186-0217310

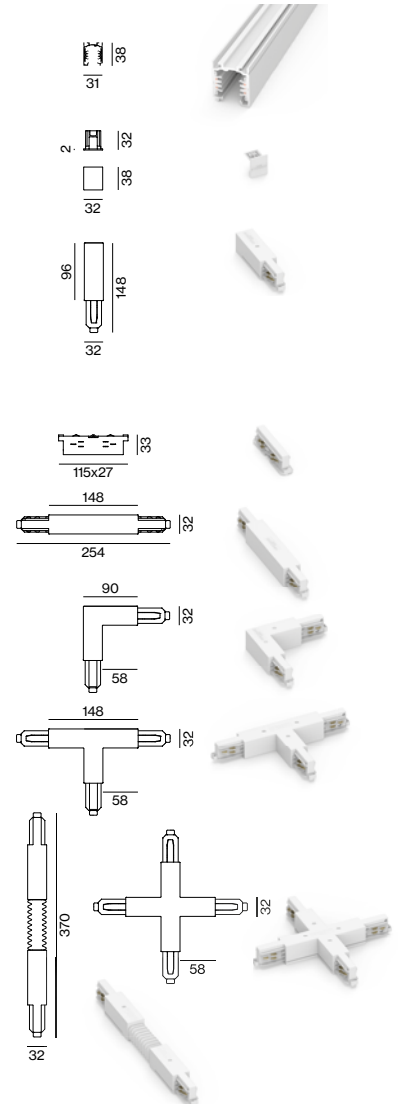

TRACK high

surface/suspended

Order options

CONTROL

non DIM

DALI-2

MATERIAL COLOUR

○ pure white RAL 9010 7

● jet black RAL 9005 8

Options on request

LIGHT OPTIC COVER

inset indirect

Pole options

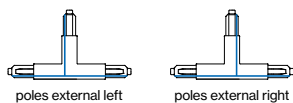
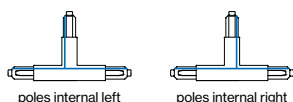

TRACK high 3-phase/3-phase + DALI-2-bus



TRACK 240V-16A

| L (mm) | ORDER CODE |
|--------|------------|
| 1000 | 186-016113 |
| 2000 | 186-016213 |
| 3000 | 186-016313 |
| 4000 | 186-016413 |

end cap 186-026011

end feed left 186-026313

end feed right 186-026413

middle feed 186-021323

CONNECTORS 240V-16A

TYPE
linear connector 186-026113

I-connector 186-026123

L-connector right 186-026133

L-connector left 186-026233

T-connector right (poles internal) 186-026143

T-connector left (poles internal) 186-026243

T-connector right (poles external) 186-026173

T-connector left (poles external) 186-026273

X-connector 186-026153

MOUNTING ACCESSORIES

TYPE
pendant clip cable 186-0265210
pendant sheet metal clip 186-0215220
pendant clip rod 186-0265410

joiner piece cable 186-0265310

joiner piece rod 186-0265510

cutting tool 186-0219110

SUSPENSION KIT

TYPE
pendant 1000 186-0216110

cable 1500 186-0217110

cable 3000 186-0217210

cable 5000 186-0217310

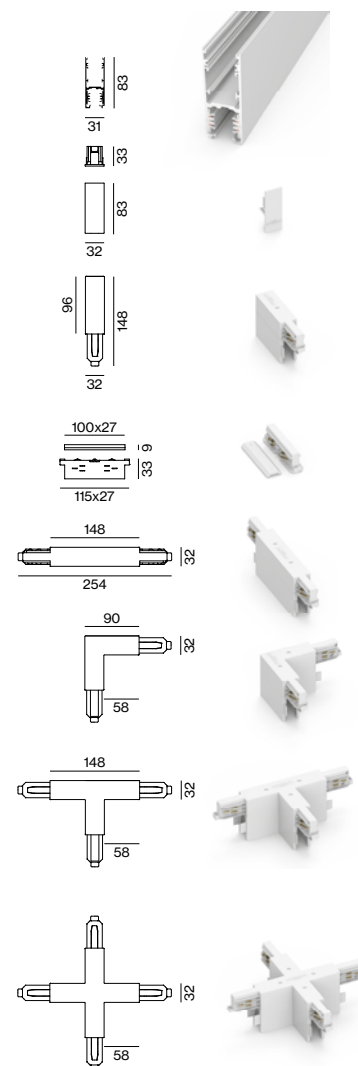

TRACK round surface/suspended

Order options

CONTROL

non DIM

DALI-2

MATERIAL COLOUR

- pure white RAL 9010 7
- jet black RAL 9005 8

Pole options

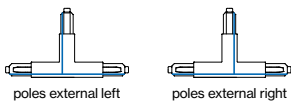
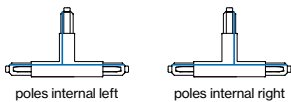

TRACK round 3-phase/3-phase + DALI-2-bus



TRACK 240V-16A

| L (mm) | ORDER CODE |
|--------|------------|
| 1000 | 186-015113 |
| 2000 | 186-015213 |
| 3000 | 186-015313 |
| 4000 | 186-015413 |



TRACK CURVE 240V-16A

| TYPE | ORDER CODE |
|-----------------|------------|
| R 500 90° left | 186-015853 |
| R 500 90° right | 186-015863 |

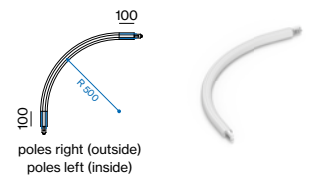

end cap 186-025011



end feed left 186-025313
 end feed right 186-025413
 middle feed 186-021323



CONNECTORS 240V-16A

linear connector 186-021113



L-connector right (external) 186-025133

L-connector left (internal) 186-025233

T-connector left (poles external) 186-025243

T-connector right (poles external) 186-025143

T-connector right (poles internal) 186-025273

T-connector left (poles internal) 186-025173

X-connector 186-025153

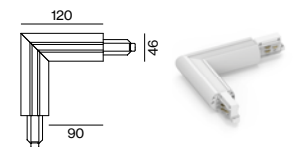

MOUNTING ACCESSORIES

pendant clip cable 186-025521
 pendant clip rod 186-025541

joiner piece cable 186-025531

joiner piece rod 186-025551

cutting tool 186-0279110

SUSPENSION KIT

pendant 1000 186-021611

cable 1500 186-0217110

cable 3000 186-0217210

cable 5000 186-0217310