

XAL

SIVERA

SIVERA 25

acoustic suspended

EN Flexible mounting system for suspending multiple baffles and luminaires; consisting of aluminium profiles, rotatable and movable mounting clips made from 3D printing and acoustic elements made of 25mm thick, high quality, self-supporting, at least 50% recycled PET felt with sound absorbing properties; high quality visual and tactile surface; linear light inset made of plastic in extruded aluminium profile; surface powder coated; high quality reflector with micro-faceted, aluminum-vaporised surface; or fitted with single LED light points; good glare reduction due to recessed light point plane; despite this increased efficiency through special lens technology; inserted lenses with wide flood radiation characteristic; precise radiation characteristic with symmetrical light distribution; or completely homogeneously illuminated, opal cover; converter integrated into the module; optionally with integrated power track profile for take off of supply voltage and DALI-2 signal; incl. feeder cable, optionally with 3-phase adapter; distance between the baffles or luminaires freely selectable; pendant fitting with cable suspension; toolless suspension height adjustment on the profile; can be extended as required via linear connector; optional: MOVE IT PRO 45 track can be integrated using accessories

IT Sistema di montaggio flessibile per sospendere più baffle e apparecchi; composto da profili in alluminio, clip di montaggio girevoli e spostabili stampati in 3D ed elementi acustici in feltro PET di alta qualità, spesso 25 mm, autoportante, riciclato almeno al 50% con proprietà fonoassorbenti; finitura con caratteristiche estetiche e tattili di alta qualità; inserto luminoso lineare in plastica nel profilo estruso in alluminio; verniciatura a polvere; riflettore di alta qualità con superficie a microfaccette e vaporizzata in alluminio; o dotato di singoli punti luce a LED; ottima schermatura con superficie di emissione arretrata; comunque maggiore efficienza con la speciale tecnologia delle lenti; lenti con emissione wide flood; caratteristica di emissione precisa con distribuzione simmetrica della luce; o illuminazione completamente omogenea, cover opalina; convertitore integrato nel modulo; in opzione con binario elettrificato integrato per la riduzione della tensione di alimentazione e segnale DALI-2; cavo di alimentazione incluso, opzionalmente con adattatore trifase; distanza tra i baffle e gli apparecchi di illuminazione può essere scelta liberamente; sospeso con cavo a sospensione; regolazione in altezza senza attrezzi sul profilo; ampliabile a piacere tramite connettori lineari; in opzione: MOVE IT PRO 45 track si può integrare tramite accessori

Quickinfo

slim baffle system
high acoustic performance

3000 K, 3500 K, 4000 K
CRI ≥ 80, CRI ≥ 90, 3 SDCM
UGR ≤ 16 / 65° ≤ 1500 cd/m²
up to 1630 lm/m | 168 lm/W
L90 @ 100 000 h
DALI-2

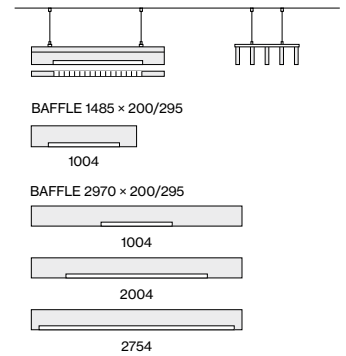

Customisable options

height
length
baffle shapes
colour

Colours



Light optics

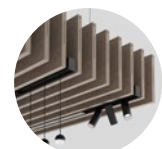
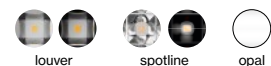

combinable with
MOVE IT PRO



power supply via
3-phase adapter

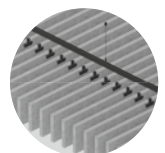

easy
mounting

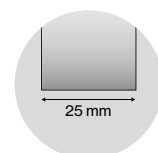

slim width
25 mm

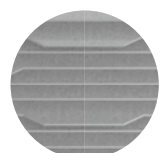

modular
system

Order options

FEEDER CABLE

- open end* 2
- with 3-phase track adapter** 3

* for canopy: 2000mm feeder cable
 ** STUCCHI adapt.: 1500mm feeder c.

BAFFLE HEIGHT LOUVER

- 200mm 1
- 295mm 2

SPOTLINE

- 200mm 3
- 295mm 4

OPAL

- 200mm 5
- 295mm 6

COLOUR TEMPERATURE

- 3000K 5
- 4000K 6

CONTROL

- DALI-2

ACOUSTIC COLOUR

- white W
- marble grey D
- felt grey G
- anthracite B
- black L
- limestone S

LUMINAIRE COLOUR

- pure white RAL9010 7
- jet black RAL9005 8

SPOTLINE COLOUR

- white 7
- black 8

LIGHT OPTIC

- louver wide flood
- spotline

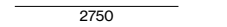
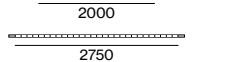
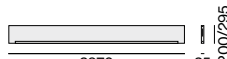
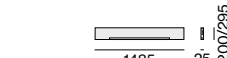
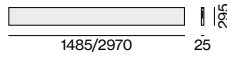
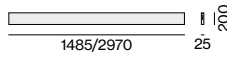

SIVERA 25 acoustic suspended

A	B	C	D	E
α _w 0.7				

0.70
NRC

0.73
SAA

BAFFLE

L-H (mm)
1485-200
1485-295
2970-200
2970-295

ORDER CODE

091-401211
091-402211
091-401411
091-402411

SIVERA 25 acoustic suspended

A	B	C	D	E
α _w 0.7				

0.70
NRC

0.73
SAA

LOUVER

SYS. POWER	L BAFFLE (mm)	L INSET (mm)	COLOUR TEMP.	LUM. FLUX	ORDER CODE
10.7W	1485	1000	3000K 4000K	1520lm 1730lm	091-4-H ₁ 0::3
10.7W	2970	1000	3000K 4000K	1520lm 1730lm	091-4-H ₁ 1::3
20.6W	2970	2000	3000K 4000K	3050lm 3470lm	091-4-H ₁ 3::3
27.5W	2970	2750	3000K 4000K	4070lm 4630lm	091-4-H ₁ 4::3

SPOTLINE

SYS. POWER	L BAFFLE (mm)	L INSET (mm)	COLOUR TEMP.	LUM. FLUX	ORDER CODE
10.7W	1485	1000	3000K 4000K	1500lm 1710lm	091-4-H ₂ 0::3
10.7W	2970	1000	3000K 4000K	1500lm 1710lm	091-4-H ₂ 1::3
20.6W	2970	2000	3000K 4000K	3000lm 3410lm	091-4-H ₂ 3::3
27.5W	2970	2750	3000K 4000K	4000lm 4560lm	091-4-H ₂ 4::3

OPAL

SYS. POWER	L BAFFLE (mm)	L INSET (mm)	COLOUR TEMP.	LUM. FLUX	ORDER CODE
9.5W	1485	1000	3000K 4000K	1080lm 1220lm	091-4-H ₃ 0::3
9.5W	2970	1000	3000K 4000K	1080lm 1220lm	091-4-H ₃ 1::3
18.3W	2970	2000	3000K 4000K	2150lm 2450lm	091-4-H ₃ 3::3
25.2W	2970	2750	3000K 4000K	2960lm 3370lm	091-4-H ₃ 4::3

Customised shapes

BAFFLE SHAPES examples

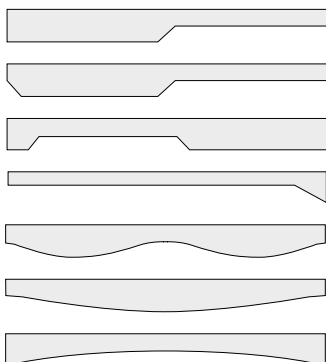

Acoustic data

SOUND ABSORPTION COEFFICIENT (α_p)

TYPE	125	250	500	1000	2000	4000 HZ
200	0.05	0.15	0.45	0.80	1.00	1.00
295	0.05	0.15	0.45	0.80	1.00	1.00

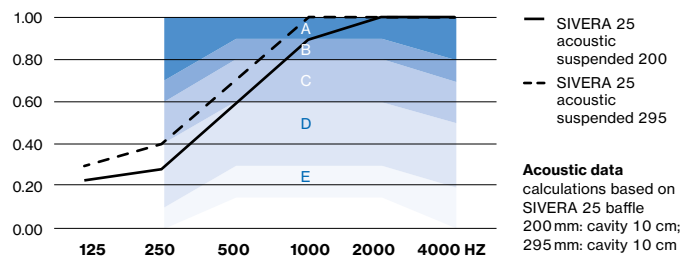

Acoustic data
 calculations based on
 SIVERA 25 baffle
 200mm: cavity 10 cm;
 295mm: cavity 10 cm



SIVERA



Quickinfo

slim baffle system
high acoustic performance

2700 K, 3000 K, 3500 K, 4000 K
CRI ≥ 90
L90 @ 50 000h
DALI-2

Types

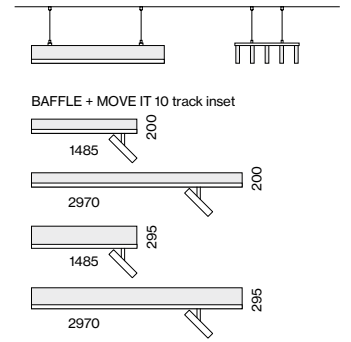

Customisable options

height
length
colour

Colours



combinable with
MOVE IT 10 insets



power supply via
3-phase adapter

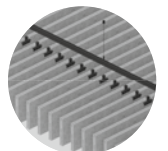

easy
mounting

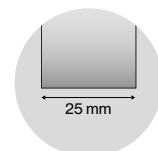

slim width
25 mm

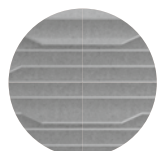

modular
system

SIVERA 25 track

acoustic suspended

Order options

FEEDER CABLE	
open end*	2
3-phase track**	3

* for canopy: 3000mm feeder cable
 ** incl. 30W conv. 48V: 1500mm feeder c.

BAFFLE HEIGHT	
200 mm	7
295 mm	8

CONTROL	
DALI-2	

ACOUSTIC COLOUR	
<input type="radio"/> white	W
<input type="radio"/> marble grey	D
<input type="radio"/> felt grey	G
<input type="radio"/> anthracite	B
<input type="radio"/> black	L
<input type="radio"/> limestone	S

TRACK COLOUR	
<input type="radio"/> pure white RAL9010	7
<input type="radio"/> jet black RAL9005	8

ACCESSORY COLOUR	
<input type="radio"/> pure white RAL9010	7
<input type="radio"/> jet black RAL9005	8

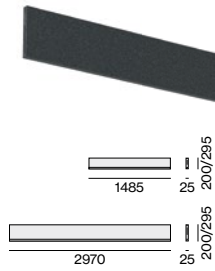

SIVERA 25 acoustic suspended

	A B C D E	0.70	0.73
	$\alpha_w 0.7$	NRC	SAA

TRACK 48V

L (mm)		ORDER CODE
1485		091-4-H003
2970		091-4-H103

Electrical accessories

POWER SUPPLY SURFACE supply 220-240V AC, 48V, 50-60 Hz



TYPE	EFFICIENCY	MOUNTING	L-W-H (MM)	ORDER CODE
60W <input type="checkbox"/> PC II η 88%		surface	305-144-54	050-20551
100W <input type="checkbox"/> PC II η 92%		surface	455-104-40	050-20554
150W <input type="checkbox"/> PC II η 92%		surface	455-104-40	050-20552
250W <input type="checkbox"/> PC II η 93%		surface	455-104-40	050-20555
320W <input type="checkbox"/> PC I η 94%		surface	305-144-54	050-20553

ENEC approved; DALI-2 SELV device integrated

Acoustic data

SOUND ABSORPTION COEFFICIENT (α_p)

TYPE	125	250	500	1000	2000	4000 HZ
200	0.05	0.15	0.45	0.80	1.00	1.00
295	0.05	0.15	0.45	0.80	1.00	1.00

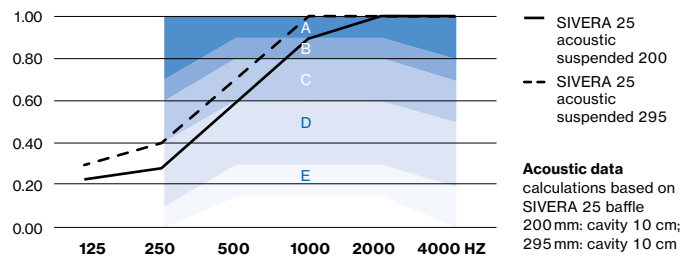

Configuration example

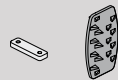
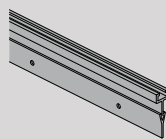
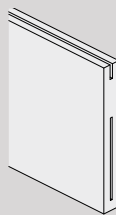
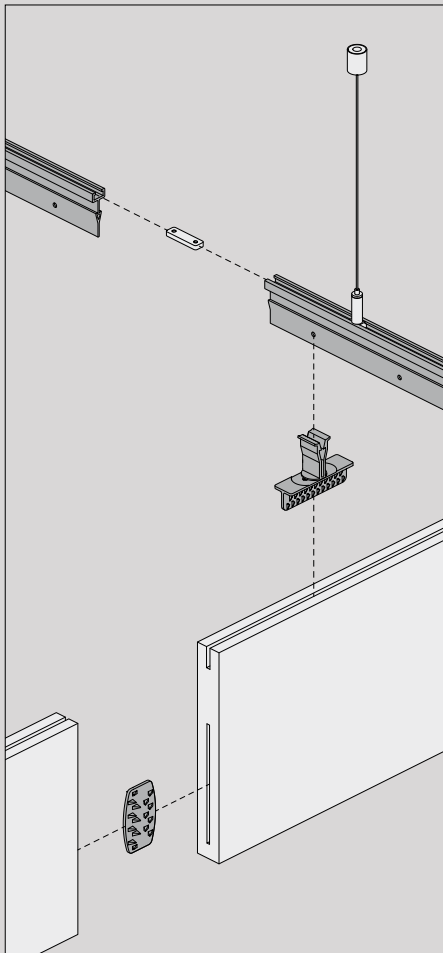
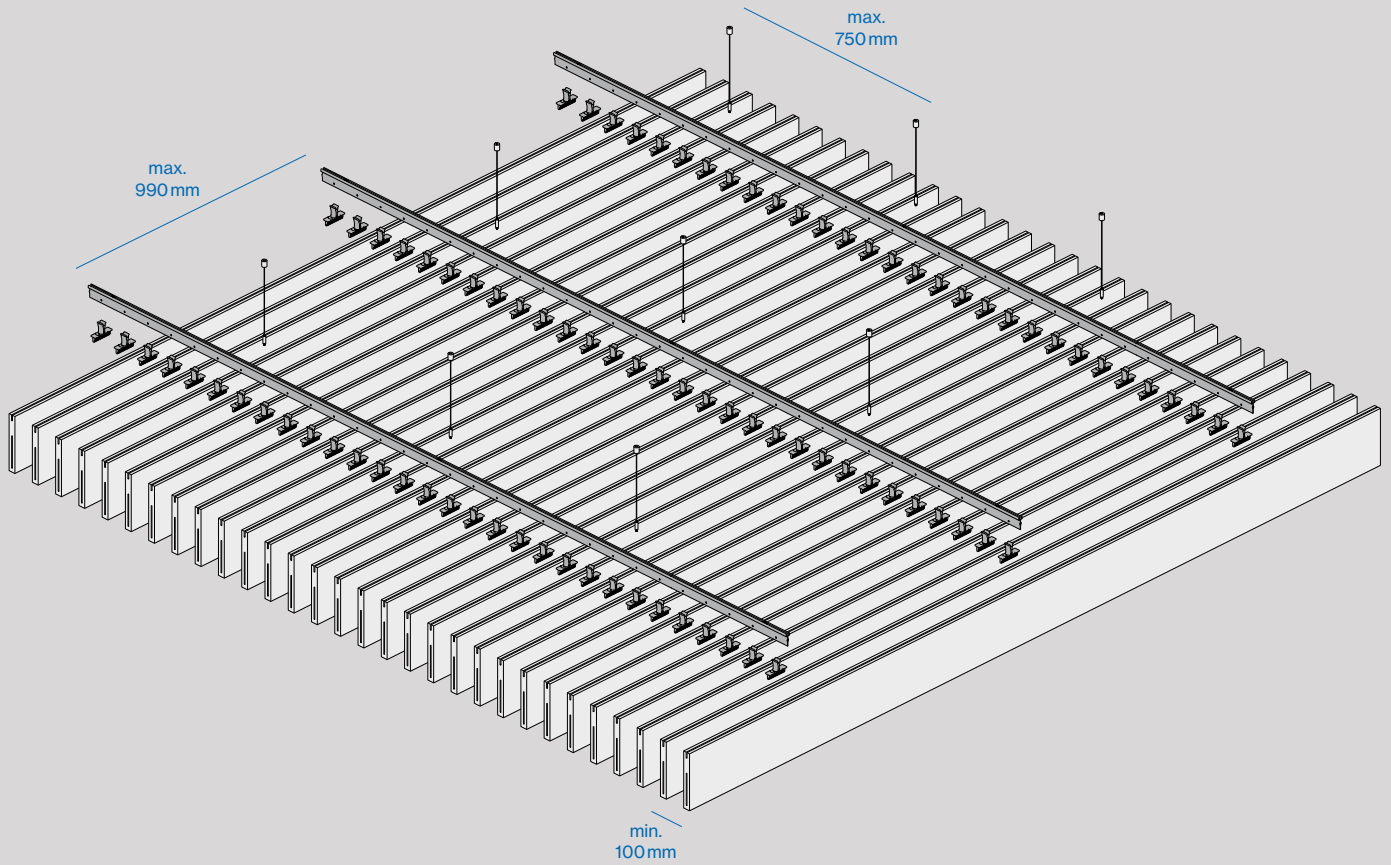

MOUNTING PROFILE

CABLE SUSPENSION

LINEAR CONNECTOR

Order options

ACCESSORY COLOUR		■
○ pure white	RAL9010	7
● jet black	RAL9005	8

SET AMOUNT		#
set of 3 pieces		0
set of 30 pieces		1

Mounting accessories

MOUNTING PROFILE

L (mm)

3000

ORDER CODE

091-4092118

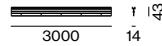

profile holds up to 30 baffles (baffle distance center to center 100 mm); 2 mounting profiles needed for 1485 mm baffle, 3 mounting profiles for 2970 mm; mounting profile distance 990 mm

MOUNTING SET for BAFFLE

TYPE

turnable + moveable (+/- 10 mm) for mounting profile

ORDER CODE

091-409#018



used to fix the baffle onto the mounting profile, 2 mounting sets required for each 1485 mm baffle, 3 mounting sets required for each 2970 mm baffle

MOUNTING SET for MOVE IT PRO track

TYPE

single piece

ORDER CODE

091-4090218

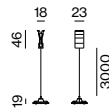

needed to mount a MOVE IT PRO track to the mounting profile, suitable for both baffle heights due to an adjustable cable suspension

LINEAR CONNECTOR

TYPE

for mounting profile

for baffle set of 10 pieces

ORDER CODE

091-4095010

091-4095118



CABLE SUSPENSION

TYPE

for mounting profile set of 3 pieces

L (mm)

3000

ORDER CODE

091-4093118

one set of three per mounting profile needed



CANOPY

TYPE

canopy

ORDER CODE

005-231121 ■

