

YAL

SIVERA

SIVERA 25

acoustic suspended

EN Flexible mounting system for suspending multiple baffles and luminaires; consisting of aluminium profiles, rotatable and movable mounting clips made from 3D printing and acoustic elements made of 25mm thick, high quality, self-supporting, at least 50 % recycled PET felt with sound absorbing properties; high quality visual and tactile surface; linear light inset made of plastic in extruded aluminium profile; surface powder coated; high quality reflector with micro-faceted, aluminum-vaporised surface; or fitted with single LED light points; good glare reduction due to recessed light point plane; despite this increased efficiency through special lens technology; inserted lenses with wide flood radiation characteristic; precise radiation characteristic with symmetrical light distribution; or completely homogeneously illuminated, opal cover; converter integrated into the module; optionally with integrated power track profile for take off of supply voltage and DALI-2 signal; incl. feeder cable, optionally with 3-phase adapter; distance between the baffles or luminaires freely selectable; pendant fitting with cable suspension; toolless suspension height adjustment on the profile; can be extended as required via linear connector; optional: MOVE IT PRO 45 track can be integrated using accessories

FR Système de montage flexible pour la suspension de multiples baffles et luminaires ; composé de profilés en aluminium, de clips de montage pivotants et amovibles imprimés en 3D et d'éléments acoustiques en feutre PET haute qualité de 25 mm d'épaisseur, autoportants, recyclés à au moins 50 % et dotés de propriétés d'absorption acoustique ; surface aux grandes qualités visuelles et tactiles ; insert lumineux linéaire en plastique dans le profilé extrudé en aluminium ; surface thermolaquée ; réflecteur de grande qualité avec surface à microfacettes, métallisée à l'aluminium ; ou équipé de points lumineux à LED simples ; bon anti-éblouissement grâce aux points lumineux en retrait ; malgré tout efficacité accrue grâce à une tech. de lentilles spéciale ; lentilles utilisées avec caractéristique de rayonnement wide flood ; caractéristique d'émission précise avec répartition symétrique de la lumière ; ou éclairage parfaitement homogène, cache opale ; convertisseur intégré au module ; en option avec profil de rail intégré pour fixation d'alimentation électrique et signal DALI-2 ; câble d'alimentation inclus, avec adaptateur triphasé en option ; espacement entre les baffles et les luminaires librement sélectionnable ; suspension par câble ; règle de hauteur sans outil sur le profil ; extensible à volonté grâce à des raccords linéaires ; en option : MOVE IT PRO 45 track peut être intégré en utilisant des accessoires

Quickinfo

slim baffle system
high acoustic performance

3000 K, 3500 K, 4000 K
CRI ≥ 80, CRI ≥ 90, 3 SDCM
UGR ≤ 16 / 65° ≤ 1500 cd/m²
up to 1630 lm/m | 168 lm/W
L90 @ 100 000 h
DALI-2

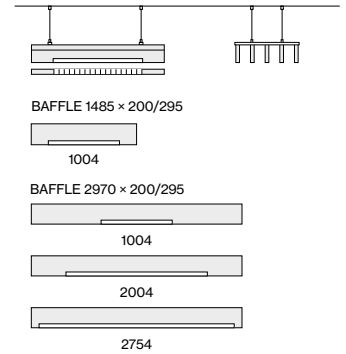

Customisable options

height
length
baffle shapes
colour

Colours



Light optics

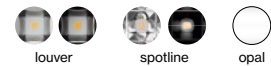

combinable with
MOVE IT PRO



power supply via
3-phase adapter

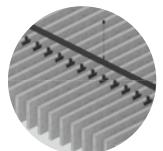

easy
mounting

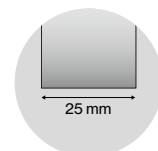

slim width
25 mm

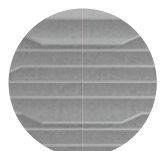

modular
system

Order options

FEEDER CABLE

- open end* 2
- with 3-phase track adapter** 3

* for canopy: 2000mm feeder cable
 ** STUCCHI adapt.: 1500mm feeder c.

BAFFLE HEIGHT LOUVER

- 200mm 1
- 295mm 2

SPOTLINE

- 200mm 3
- 295mm 4

OPAL

- 200mm 5
- 295mm 6

COLOUR TEMPERATURE

- 3000K 5
- 4000K 6

CONTROL

- DALI-2

ACOUSTIC COLOUR

- white W
- marble grey D
- felt grey G
- anthracite B
- black L
- limestone S

LUMINAIRE COLOUR

- pure white RAL9010 7
- jet black RAL9005 8

SPOTLINE COLOUR

- white 7
- black 8

LIGHT OPTIC

- louver wide flood
- spotline

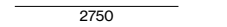
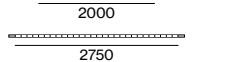
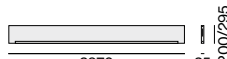
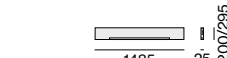
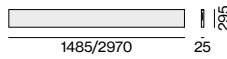
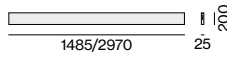

SIVERA 25 acoustic suspended

A	B	C	D	E
α _w 0.7				

0.70
NRC

0.73
SA

BAFFLE

L-H (mm)
1485-200
1485-295
2970-200
2970-295

ORDER CODE

091-401211
091-402211
091-401411
091-402411

SIVERA 25 acoustic suspended

A	B	C	D	E
α _w 0.7				

0.70
NRC

0.73
SA

LOUVER

SYS. POWER	L BAFFLE (mm)	L INSET (mm)	COLOUR TEMP.	LUM. FLUX	ORDER CODE
10.7W	1485	1000	3000K 4000K	1520lm 1730lm	091-4-H ₁ 0::3
10.7W	2970	1000	3000K 4000K	1520lm 1730lm	091-4-H ₁ 1::3
20.6W	2970	2000	3000K 4000K	3050lm 3470lm	091-4-H ₁ 3::3
27.5W	2970	2750	3000K 4000K	4070lm 4630lm	091-4-H ₁ 4::3

SPOTLINE

SYS. POWER	L BAFFLE (mm)	L INSET (mm)	COLOUR TEMP.	LUM. FLUX	ORDER CODE
10.7W	1485	1000	3000K 4000K	1500lm 1710lm	091-4-H ₂ 0::3
10.7W	2970	1000	3000K 4000K	1500lm 1710lm	091-4-H ₂ 1::3
20.6W	2970	2000	3000K 4000K	3000lm 3410lm	091-4-H ₂ 3::3
27.5W	2970	2750	3000K 4000K	4000lm 4560lm	091-4-H ₂ 4::3

OPAL

SYS. POWER	L BAFFLE (mm)	L INSET (mm)	COLOUR TEMP.	LUM. FLUX	ORDER CODE
9.5W	1485	1000	3000K 4000K	1080lm 1220lm	091-4-H ₃ 0::3
9.5W	2970	1000	3000K 4000K	1080lm 1220lm	091-4-H ₃ 1::3
18.3W	2970	2000	3000K 4000K	2150lm 2450lm	091-4-H ₃ 3::3
25.2W	2970	2750	3000K 4000K	2960lm 3370lm	091-4-H ₃ 4::3

Customised shapes

BAFFLE SHAPES examples

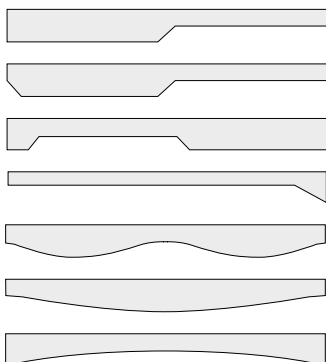

Acoustic data

SOUND ABSORPTION COEFFICIENT (α_p)

TYPE	125	250	500	1000	2000	4000 HZ
200	0.05	0.15	0.45	0.80	1.00	1.00
295	0.05	0.15	0.45	0.80	1.00	1.00

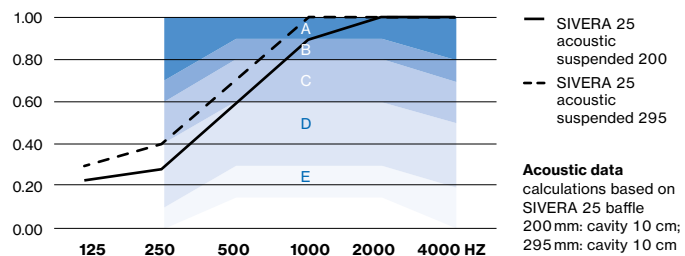



SIVERA



Quickinfo

slim baffle system
high acoustic performance

2700 K, 3000 K, 3500 K, 4000 K
CRI ≥ 90
L90 @ 50 000h
DALI-2

Types

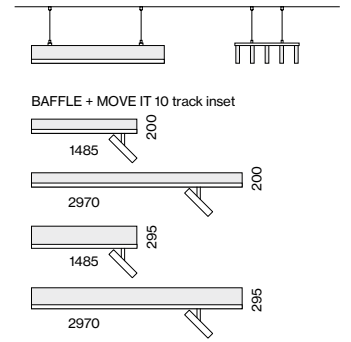

Customisable options

height
length
colour

Colours



combinable with
MOVE IT 10 insets



power supply via
3-phase adapter

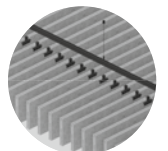

easy
mounting

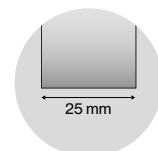

slim width
25 mm

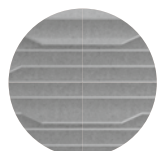

modular
system

SIVERA 25 track

acoustic suspended

Order options

FEEDER CABLE

- open end* 2
- 3-phase track** 3

* for canopy: 3000mm feeder cable
 ** incl. 30W conv. 48V: 1500mm feeder c.

BAFFLE HEIGHT

- 200 mm 7
- 295 mm 8

CONTROL

- DALI-2

ACOUSTIC COLOUR

- white W
- marble grey D
- felt grey G
- anthracite B
- black L
- limestone S

TRACK COLOUR

- pure white RAL9010 7
- jet black RAL9005 8

ACCESSORY COLOUR

- pure white RAL9010 7
- jet black RAL9005 8

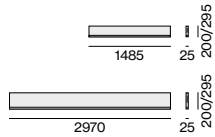

SIVERA 25 acoustic suspended

PET felt	A B C D E	0.70 NRC	0.73 SAA
$\alpha_w 0.7$			

TRACK 48V

L (mm)
1485
2970

ORDER CODE

091-4- H 003
091-4- H 103

Electrical accessories

POWER SUPPLY SURFACE supply 220-240V AC, 48V, 50-60 Hz



TYPE	EFFICIENCY	MOUNTING	L-W-H (MM)	ORDER CODE
60W PC II	η 88%	surface	305-144-54	050-20551
100W PC II	η 92%	surface	455-104-40	050-20554
150W PC II	η 92%	surface	455-104-40	050-20552
250W PC II	η 93%	surface	455-104-40	050-20555
320W PC I	η 94%	surface	305-144-54	050-20553

ENEC approved; DALI-2 SELV device integrated

Acoustic data

SOUND ABSORPTION COEFFICIENT (α_p)

TYPE	125	250	500	1000	2000	4000 HZ
200	0.05	0.15	0.45	0.80	1.00	1.00
295	0.05	0.15	0.45	0.80	1.00	1.00

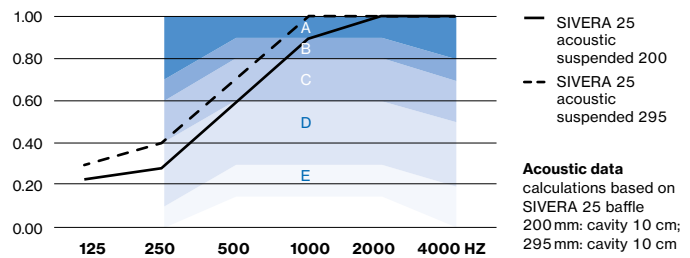

Configuration example

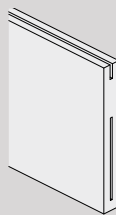
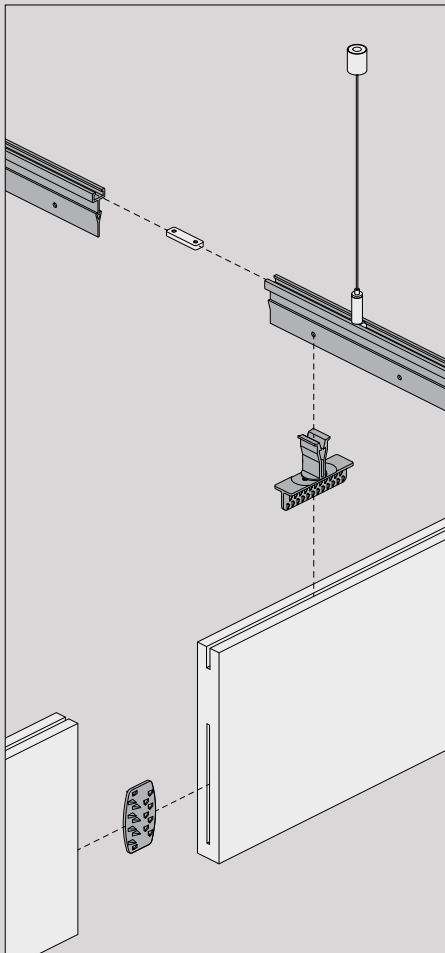
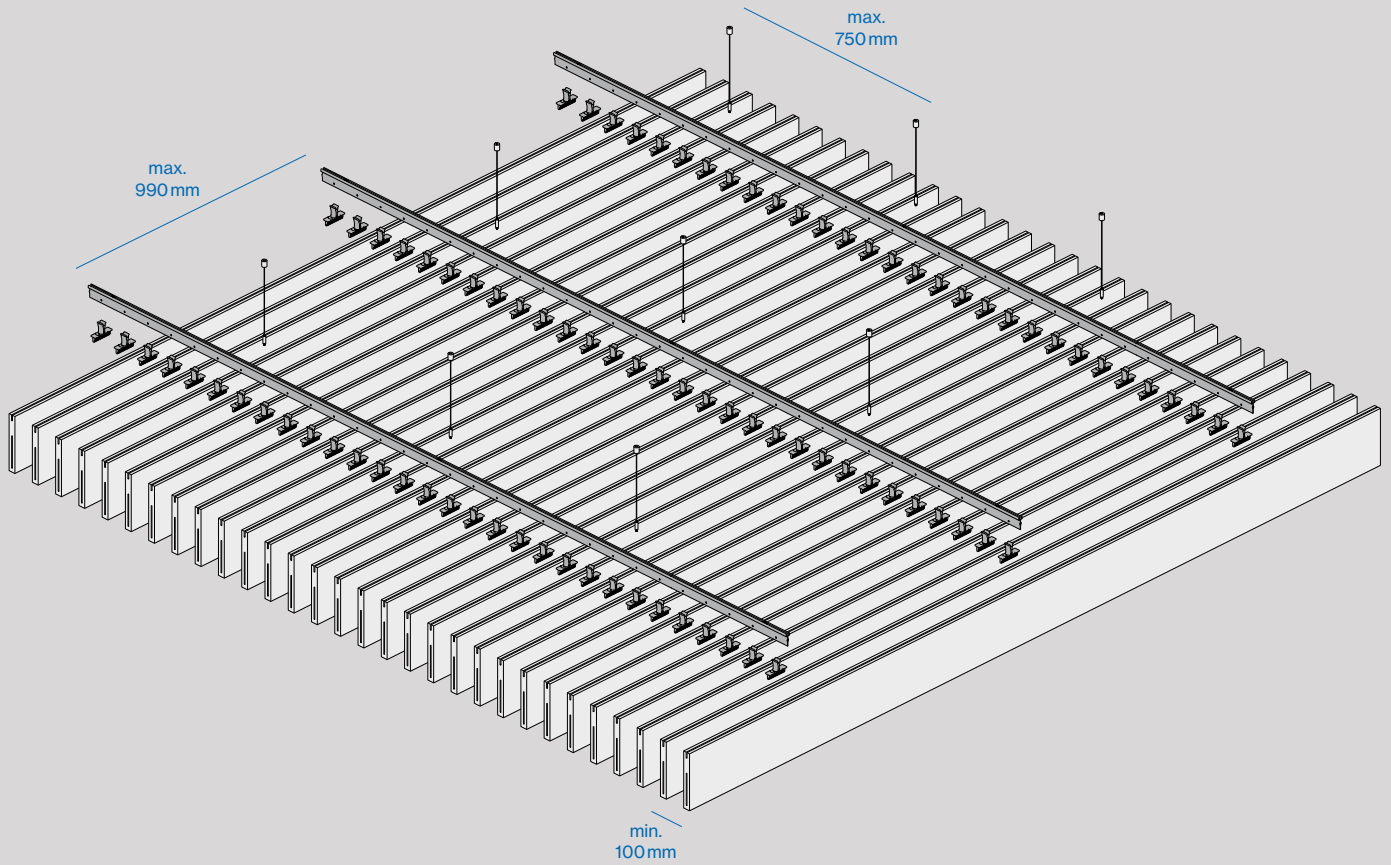

BAFFLE



MOUNTING SET for BAFFLE



MOUNTING SET for MOVE IT PRO track

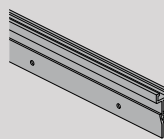

MOUNTING PROFILE



CABLE SUSPENSION

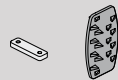

LINEAR CONNECTOR

Order options

ACCESSORY COLOUR		■
○ pure white RAL9010	7	
● jet black RAL9005	8	

SET AMOUNT		#
set of 3 pieces	0	
set of 30 pieces	1	

Mounting accessories

MOUNTING PROFILE

L (mm)

3000

ORDER CODE

091-4092118

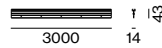

profile holds up to 30 baffles (baffle distance center to center 100 mm); 2 mounting profiles needed for 1485 mm baffle, 3 mounting profiles for 2970 mm; mounting profile distance 990 mm

MOUNTING SET for BAFFLE

TYPE

turnable + moveable (+/- 10 mm) for mounting profile

ORDER CODE

091-409#018



used to fix the baffle onto the mounting profile, 2 mounting sets required for each 1485 mm baffle, 3 mounting sets required for each 2970 mm baffle

MOUNTING SET for MOVE IT PRO track

TYPE

single piece

ORDER CODE

091-4090218

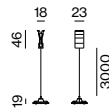

needed to mount a MOVE IT PRO track to the mounting profile, suitable for both baffle heights due to a adjustable cable suspension

LINEAR CONNECTOR

TYPE

for mounting profile

for baffle set of 10 pieces

ORDER CODE

091-4095010

091-4095118



CABLE SUSPENSION

TYPE

for mounting profile set of 3 pieces

L (mm)

3000

ORDER CODE

091-4093118

one set of three per mounting profile needed



CANOPY

TYPE

canopy

ORDER CODE

005-231121 ■

