

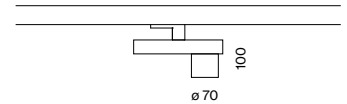

**Quickinfo**

3000K, 4000K  
 CRI ≥ 90, 2 SDCM  
 up 76lm/W  
 L85 @ 50000h  
 DIM POTI

**Type**



**Colours**



**Light distributions**



**PABLO multilens**

track

**EN** Track light made of die-cast aluminium; powder coated; 360° rotatable and 310° tiltable; converter installed in aluminium spotlight housing; COB (Chip on Board) technology for maximum efficiency; no multiple shadows; energy-eff. LEDs – very good colour rendering; exchangeable additional lenses; precise radiation characteristics with different beam angles; installed and exchanged without tools; optical attachments as accessories; adapter for toolless insertion or movement on a variety of 3-phase power tracks; adapter fixation optionally without tools by means of knurled screw or set screw (screwdriver required); point outlet, either in surface mounted housing or recessed housing, as an accessory

**ES** Proyector de carril electrificado de fundición de aluminio inyectado; recubierto de polvo; giratorio 360° y orientable 310°; convertidor montado en carcasa de proyector de aluminio; con tecnología COB (Chip on Board) para proporcionar una máxima eficiencia; no sombras múltiples; LED energét. efic. – excelente reprod. crom.; lentes reemplazables; característica de emisión precisa con diferentes ángulos de emisión; intercambiable sin herramienta; los accesorios ópticos como accesorios; adaptador para instalación sin herramientas o desplazamiento en diferentes carriles electrificados de 3 fases; fijación de adaptador sin herramienta con tornillo moleteado o tornillo de sujeción (destornillador necesario); base para techo, opcionalmente en carcasa superpuesta o carcasa empotrada, como accesorio



DiiA® standards  
 251, 252, 253



interchangeable  
 diffusion sheets



360° rotatable  
 310° tiltable



DIM POTI/  
 rotation lock

## Order options

### ADAPTER FIXATION

tool-free fixation	2
set screw (tool required)	1

### COLOUR TEMPERATURE

3000K	5
4000K	6

### CONTROL

DIM POTI

### MATERIAL COLOUR

<input type="radio"/> traffic white RAL 9016	7
<input checked="" type="radio"/> jet black RAL 9005	8

### BEAM ANGLE

10/19/30/38/40/64°

## Options on request

### CONTROL

DALI-2

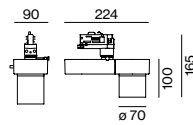

## PABLO multilens 10–60°



### TRACK LIGHT

SYS. POWER	COLOUR TEMPERATURE	LUMINOUS FLUX	ORDER CODE
14.8W	3000K	1050lm	1 8 0 - 5 7 0 0 :: 8 
	4000K	1130lm	

incl. 5 pcs. interchangeable diffusion sheets



## Optical accessories

### OVAL FILTER

TYPE	ORDER CODE
oval filter 60 × 15°	0 8 0 - 5 9 0 0 0 2 0
diffusion sheet for superspot*	0 8 0 - 5 9 0 0 0 3 0

\*for a better homogeneous illumination

## Mounting accessories

### SURFACE HOUSING/POINT OUTLET

TYPE	ORDER CODE
surface housing/point outlet	1 8 6 - 0 7 2 2 8 

### RECESSED HOUSING/POINT OUTLET

ceiling thickness: 1-30 mm

TYPE	ORDER CODE
recessed housing/point outlet	1 8 6 - 0 7 2 2 7 

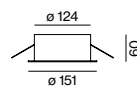



**Types**

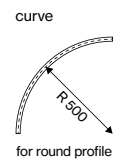
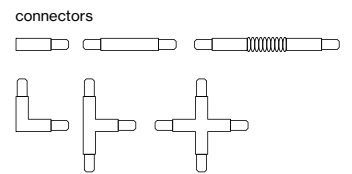
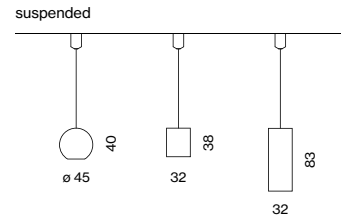
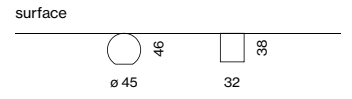
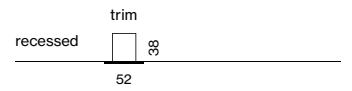

**Colours**



**TRACK 3-phase**  
recessed/surface/suspended



# TRACK recessed

## Order options

### CONTROL

non DIM

DALI-2

### MATERIAL COLOUR

- pure white RAL 9010 7
- jet black RAL 9005 8

## Pole options

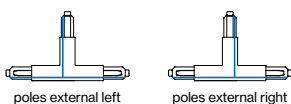
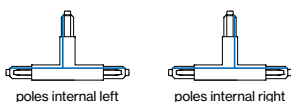

## TRACK 3-phase/3-phase + DALI-2-bus



### TRACK 240V-16A

L (mm)	ORDER CODE
2000	186-012213
3000	186-012313
4000	186-012413

end cap 186-022011

end feed left 186-022313  
 end feed right 186-022413  
 middle feed 186-021323

### CONNECTORS 240V-16A

**TYPE**      **ORDER CODE**  
 linear connector 186-021113

I-connector 186-022123

L-connector right 186-022133  
 L-connector left 186-022233

T-connector right (poles internal) 186-022143  
 T-connector left (poles internal) 186-022243  
 T-connector right (poles external) 186-022173  
 T-connector left (poles external) 186-022273

X-connector 186-022153

### MOUNTING ACCESSORIES

**TYPE**      **ORDER CODE**  
 clip 186-022511  
 cutting tool 186-021911

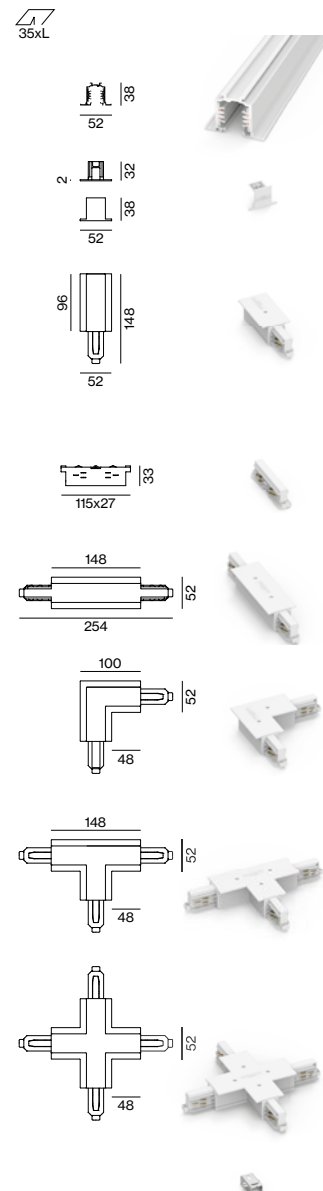

# TRACK

## surface/suspended

### Order options

#### CONTROL

non DIM

DALI-2

#### MATERIAL COLOUR

○ pure white RAL 9010	7
● white aluminium RAL 9006	6
● jet black RAL 9005	8

### Pole options

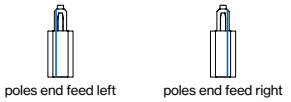
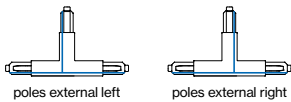
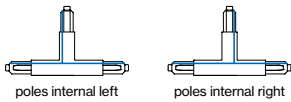

### TRACK 3-phase/3-phase + DALI-2-bus



#### TRACK 240V-16A

L (mm)	ORDER CODE
1000	186-011123
2000	186-011223
3000	186-011323
4000	186-011423

end cap 186-021011

end feed left 186-021313

end feed right 186-021413

middle feed\* 186-021323

\*only available in white and black

#### CONNECTORS 240V-16A

TYPE ORDER CODE  
 linear connector 186-021113

I-connector 186-021123

L-connector right 186-021133

L-connector left 186-021233

T-connector right (poles internal) 186-021143

T-connector left (poles internal) 186-021243

T-connector right (poles external) 186-021173

T-connector left (poles external) 186-021273

X-connector 186-021153

adjustable corner connector 186-021163

#### MOUNTING ACCESSORIES

TYPE ORDER CODE  
 ceiling clip 186-021511

pendant clip cable 186-021521

pendant clip rod 186-021541

joiner piece cable 186-021531

joiner piece rod 186-021551

cutting tool 186-0219110

#### SUSPENSION KIT

TYPE ORDER CODE  
 pendant 1000 186-021611

cable 1500 186-0217110

cable 3000 186-0217210

cable 6200 186-0217310

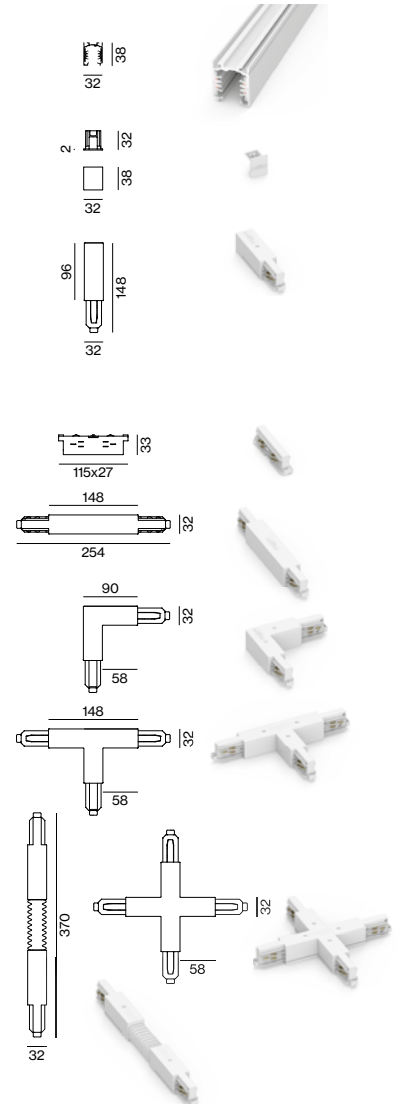

# TRACK high

## surface/suspended

### Order options

#### CONTROL

non DIM

DALI-2

#### MATERIAL COLOUR

- pure white RAL 9010 7
- jet black RAL 9005 8

### Options on request

#### LIGHT OPTIC COVER

inset indirect

### Pole options

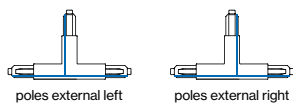
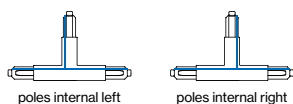

### TRACK high 3-phase/3-phase + DALI-2-bus



#### TRACK 240V-16A

L (mm)	ORDER CODE
1000	186-016113
2000	186-016213
3000	186-016313
4000	186-016413

end cap 186-026011

end feed left 186-026313

end feed right 186-026413

middle feed 186-021323

#### CONNECTORS 240V-16A

**TYPE** **ORDER CODE**

linear connector 186-026113

L-connector 186-026123

L-connector right 186-026133

L-connector left 186-026233

T-connector right (poles internal) 186-026143

T-connector left (poles internal) 186-026243

T-connector right (poles external) 186-026173

T-connector left (poles external) 186-026273

X-connector 186-026153

#### MOUNTING ACCESSORIES

**TYPE** **ORDER CODE**

pendant clip cable 186-0265210

pendant sheet metal clip 186-0215220

pendant clip rod 186-0265410

joiner piece cable 186-0265310

joiner piece rod 186-0265510

cutting tool 186-0219110

#### SUSPENSION KIT

**TYPE** **ORDER CODE**

pendant 1000 186-0216110

cable 1500 186-0217110

cable 3000 186-0217210

cable 6200 186-0217310

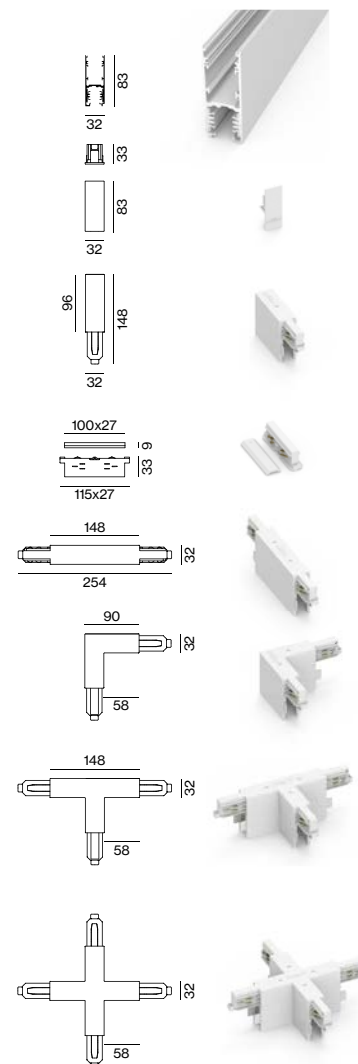

# TRACK round surface/suspended

## Order options

### CONTROL

non DIM \_\_\_\_\_  
DALI-2 \_\_\_\_\_

### MATERIAL COLOUR

○ pure white RAL 9010  7  
● jet black RAL 9005  8

## Options on request

### CONNECTOR

T-connector \_\_\_\_\_  
X-connector \_\_\_\_\_

## TRACK round 3-phase/3-phase + DALI-2-bus



### TRACK 240V-16A

L (mm)	ORDER CODE
1000	186-015113 <input checked="" type="checkbox"/>
2000	186-015213 <input checked="" type="checkbox"/>
3000	186-015313 <input checked="" type="checkbox"/>
4000	186-015413 <input checked="" type="checkbox"/>

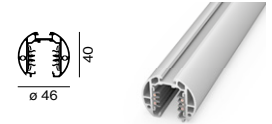

### TRACK CURVE 240V-16A

TYPE	ORDER CODE
R 500 90° left	186-015853 <input checked="" type="checkbox"/>
R 500 90° right	186-015863 <input checked="" type="checkbox"/>

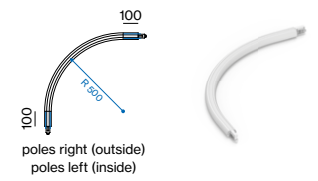

end cap \_\_\_\_\_ 186-025011



end feed left \_\_\_\_\_ 186-025313   
end feed right \_\_\_\_\_ 186-025413   
middle feed \_\_\_\_\_ 186-021323



### CONNECTORS 240V-16A

TYPE	ORDER CODE
linear connector	186-021113 <input checked="" type="checkbox"/>
L-connector right	186-025133 <input checked="" type="checkbox"/>
L-connector left	186-025233 <input checked="" type="checkbox"/>

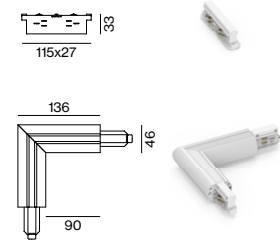

### MOUNTING ACCESSORIES

TYPE	ORDER CODE
pendant clip cable	186-025521 <input checked="" type="checkbox"/>
pendant clip rod	186-025541 <input checked="" type="checkbox"/>

joiner piece cable \_\_\_\_\_ 186-025531   
joiner piece rod \_\_\_\_\_ 186-025551

cutting tool \_\_\_\_\_ 186-0219110

### SUSPENSION KIT

TYPE	ORDER CODE
pendant 1000	186-021611 <input checked="" type="checkbox"/>
cable 1500	186-0217110
cable 3000	186-0217210
cable 6200	186-0217310