



Description

EN Midget luminaire profile made of extruded aluminium; surface black or natural anodised; $\pm 15^\circ$ tiltable; plug and play electrical connector system for toolless mounting; flexible connectors for mechanical and electrical connection available; available in 4 beam angles; passively cooled high-power LED system; available in the light colours 3000K and 4000K; min. 90% of the luminous flux after 50 000 hours; colour rendering $CRI \geq 95$ ($R9 \geq 90$); variant with 50 or 75mm light point spacing; 700mA converter plug and play; converter separately available; degree of protection IP20; PC II (power supply) or PC III (light insets); optionally non-dimmable or DALI-2 control

ES Perfil portalámparas de miniatura de aluminio extruido; superficie anodizada negra o natural; orientable $\pm 15^\circ$; sistema de conexión eléctrico metalizado para un montaje sin herramientas; conector flex para conexión mecánica y eléctrica disponible; disponible en 4 diferentes ángulos de emisión; sistema LED de alta potencia con refrigeración pasiva; disponible en 3000K y 4000K; mínimo 90% del flujo luminoso después de 50.000 h de vida útil; rendimiento de color $CRI \geq 95$ ($R9 \geq 90$); variante con distancia de punto de luz de 50 o bien 75 mm; convertidor de 700 mA prefabricado listo para enchufar; el convertidor debe encargarse por separado; protección IP20; CP II (fuente de alimentación) o CP III (elementos de luz); opcional no atenuable o control con DALI-2

NANO turn
recessed

Quickinfo

3000 K, 4000 K
 $CRI \geq 95$ ($R9 \geq 90$)
 L90 @ 50 000 h
 up to 1130 lm/m
 non DIM, DALI-2

Types

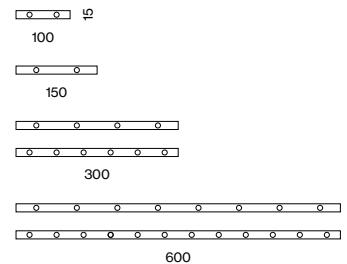

Colours



Light distributions



Order options

COLOUR TEMPERATURE

3000K CRI \geq 95 90lm*	5
4000K CRI \geq 95 100lm*	6

*per LED | CRI \geq 95 (R9 \geq 90) | 350mA | 60°C

MATERIAL COLOUR

anodised aluminium	6
anodised black	8



BEAM ANGLE

spot 20°	S
medium 30°	M
flood 40°	F
wide flood 65°	W



NANO turn

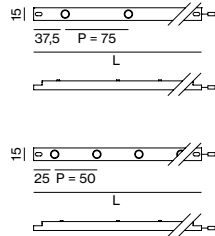
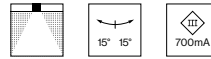

P = LED pitch

SYSTEM POWER / VOLTAGE	NO. OF LEDS	L P (mm)	ORDER CODE
2x1.2W / 3V	2	100 50	007-40101 1
2x1.2W / 3V	2	150 75	007-40011 1
4x1.2W / 6V	4	300 75	007-40031 1
6x1.2W / 9V	6	300 50	007-40131 1
8x1.2W / 12V	8	600 75	007-40061 1
12x1.2W / 18V	12	600 50	007-40161 1

ILLUMINANCE EXAMPLE (E_{max} in lux)

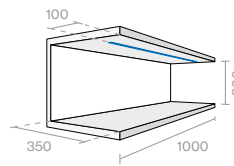

BEAM ANGLE	COLOUR TEMP.	HEIGHT 0.3 m	HEIGHT 0.3 m
		3x(4x1.2W) P=75mm	3x(6x1.2W) P=50mm
20°	3000K	5335	8025
30°	3000K	4765	7142
40°	3000K	3936	5902
65°	3000K	3030	4534

reflection factors 0.2/0.5/0.7 | maintenance factor 0.8

LIGHT DISTRIBUTION

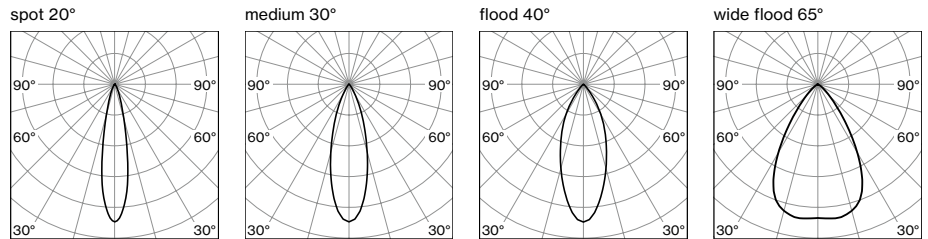

Order options

LENGTH

175 mm	0
1000 mm	2
2000 mm	4
4000 mm	6

Electrical accessories

CONVERTER supply 220-240V AC, 700 mA, 50-60 Hz, PC II

incl. power cable 2 m + connection cable with plug 1 m

TYPE	LEDS	CABLE (m)	L-W-H (mm)	ORDER CODE
8 W / 2,5-12 V non DIM	2-6	max.18	64-34-21	007-1953110
10 W / 7-14 V non DIM	6-8	max.5	95-53-25	007-1953210
20 W / 2-28 V non DIM	2-16	max.10	111-52-22	007-1953310
45 W / 20-54 V non DIM	14-32	max.11	215-70-31	007-1953510
20 W / 2-28 V DALI-2	2-16	max.10	111-52-22	007-1953330
38 W / 10-54 V DALI-2	8-32	max.11	147-44-30	007-1953530

SPLITTER SERIAL, AWG22

TYPE	INPUT / OUTPUT	L-W-H (mm)	ORDER CODE
splitter 700 mA + cable 500 mm	1x socket / 9x plug	85-50-10	007-1959310
adapter cable 100 mm	1x socket / 1x plug	-	007-1963210

EXTENSION CABLE

TYPE	INPUT / OUTPUT	L (mm)	ORDER CODE
extension cable	1x socket / 1x plug	-	007-1961110
extension cable	2x plug	75	007-1962110
extension cable	2x plug	100	007-1962210
extension cable	2x plug	125	007-1962310

Other accessories

TYPE	ORDER CODE
mounting connector: $\pm 90^\circ$ tiltable, $\pm 45^\circ$ rotatable	007-400000
end feeder (pair): $\pm 90^\circ$ tiltable	007-400010

NANO channels

Channel 90

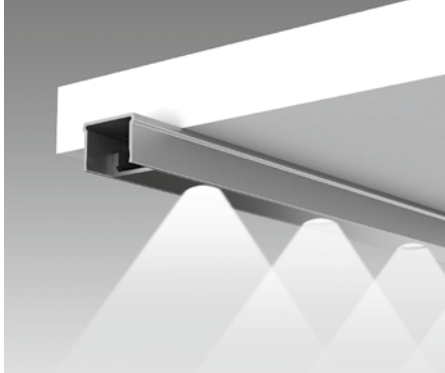

EN Mounting channel for NANO modules for recessed or surface mounting; also as higher variant (90+); variant with straight; for use with a beam angle of 90° onto the lower shelf; mounting tape available

ES Canal de montaje para módulos NANO para empotrar o adosar; adicionalmente modelo más alto (90+); terminación con corte recto; para aplicaciones con dirección de emisión de 90° sobre el estante inferior; cinta adhesiva de montaje disponible

Channel 60



EN Mounting channel for NANO modules for recessed or surface mounting; with straight cut; for use with a beam angle of 60° onto the lower shelf; optimum illumination of shelf niches with equal shelf height and depth; mounting tape available

ES Canal de montaje para módulos NANO para empotrar o adosar; terminación con corte recto; para aplicaciones con dirección de emisión de 60° sobre el estante inferior; óptima iluminación de nichos de estantes de idéntica altura y profundidad; cinta adhesiva de montaje disponible

Channel 45



EN Mounting channel for NANO modules for recessed or surface mounting; for use with a beam angle of 45° onto the lower shelf; optimum illumination of shelf niches with low height; shelf height to depth ratio of 1:2

ES Canal de montaje para módulos NANO para empotrar o adosar; para aplicaciones con dirección de emisión de 45° sobre el estante inferior; óptima iluminación de nichos de estantes de poca altura; relación entre altura y profundidad de estante de 1:2

Illuminance example

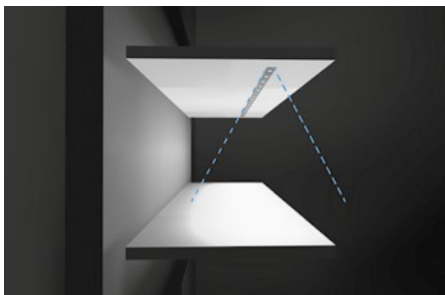

GENERAL
 NANO turn 3×(6×1.2W)
 3000 K CRI ≥ 95 (R9 ≥ 90)
 anodised aluminium
 medium 30°

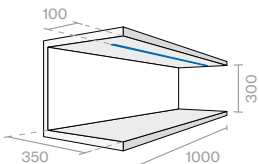

reflection factors 0.2/0.5/0.7 | maintenance factor 0.8

RESULT

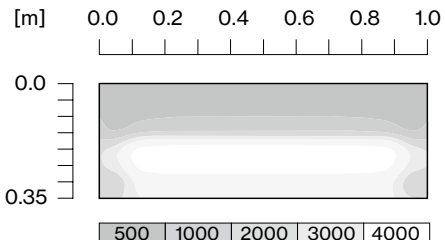

Illuminance example

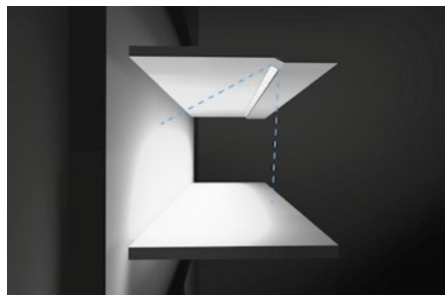

GENERAL
 NANO turn 3×(6×1.2W)
 3000 K CRI ≥ 95 (R9 ≥ 90)
 anodised aluminium
 medium 30°

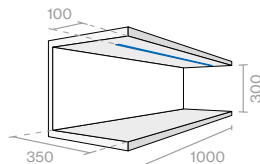

reflection factors 0.2/0.5/0.7 | maintenance factor 0.8

RESULT

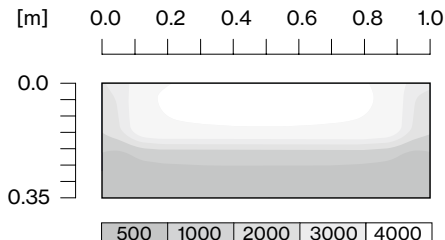

Illuminance example

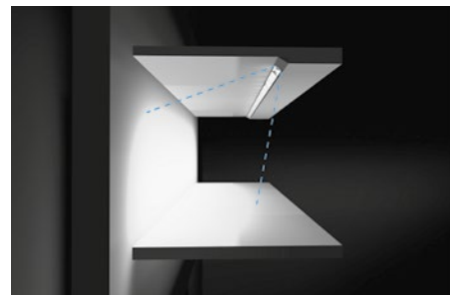

GENERAL
 NANO turn 3×(6×1.2W)
 3000 K CRI ≥ 95 (R9 ≥ 90)
 anodised aluminium
 medium 30°

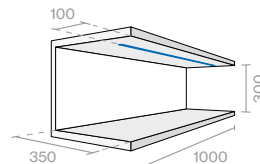

reflection factors 0.2/0.5/0.7 | maintenance factor 0.8

RESULT

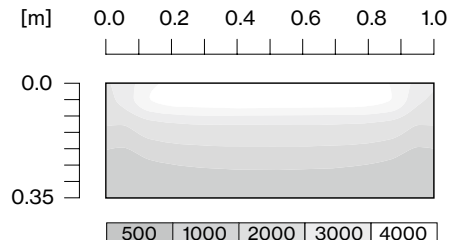

Order options

TYPE

straight cut



MATERIAL COLOUR

anodised aluminium 6
anodised black 8

6 **8**

Mounting channels

NANO CHANNEL 90

L (mm)	ORDER CODE
300	007-190104 <input checked="" type="checkbox"/>
600	007-190106 <input checked="" type="checkbox"/>
900	007-190107 <input checked="" type="checkbox"/>
1200	007-190108 <input checked="" type="checkbox"/>
3000	007-190109 <input checked="" type="checkbox"/>
custom cut (straight cut)	E 84500 ····· <input checked="" type="checkbox"/>
end caps (pair)	007-190301 <input checked="" type="checkbox"/>

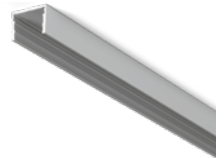

NANO CHANNEL 90+

L (mm)	ORDER CODE
300	007-190164 <input checked="" type="checkbox"/>
600	007-190166 <input checked="" type="checkbox"/>
900	007-190167 <input checked="" type="checkbox"/>
1200	007-190168 <input checked="" type="checkbox"/>
3000	007-190169 <input checked="" type="checkbox"/>
custom cut	E 84510 ····· <input checked="" type="checkbox"/>
end caps (pair)	007-191361 <input checked="" type="checkbox"/>

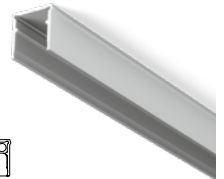
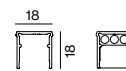

space for up to 3 pieces of power cable

NANO CHANNEL 60

L (mm)	ORDER CODE
300	007-190114 <input checked="" type="checkbox"/>
600	007-190116 <input checked="" type="checkbox"/>
900	007-190117 <input checked="" type="checkbox"/>
1200	007-190118 <input checked="" type="checkbox"/>
3000	007-190119 <input checked="" type="checkbox"/>
custom cut	E 84520 ····· <input checked="" type="checkbox"/>
end caps (pair)	007-190311 <input checked="" type="checkbox"/>

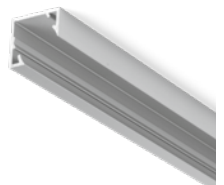
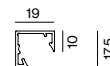

NANO CHANNEL 45

L (mm)	ORDER CODE
300	007-190124 <input checked="" type="checkbox"/>
600	007-190126 <input checked="" type="checkbox"/>
900	007-190127 <input checked="" type="checkbox"/>
1200	007-190128 <input checked="" type="checkbox"/>
3000	007-190129 <input checked="" type="checkbox"/>
custom cut	E 84530 ····· <input checked="" type="checkbox"/>
end caps (pair)	007-190321 <input checked="" type="checkbox"/>

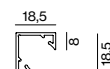

ACCESSORIES

TYPE	ORDER CODE
blind cover 150 mm	007-190281 <input checked="" type="checkbox"/>
blind cover 300 mm	007-190284 <input checked="" type="checkbox"/>
blind cover 600 mm	007-190286 <input checked="" type="checkbox"/>
tape L 3000 mm / W 18 mm	007-191919 <input checked="" type="checkbox"/>

