



BO 55/70

track

EN Track light made of die-cast aluminium; surface powder coated; spotlight head 355° rotatable and 90° tiltable; converter integrated in the power track adapter; high-quality, aluminium, vapour deposition coated reflector with faceted design; precise radiation characteristics with different beam angles; good glare reduction due to recessed light point plane; optical attachments as accessories; COB (Chip on Board) technology for maximum efficiency; no multiple shadows; energy-efficient LEDs with very good colour rendering; adapter for toolless insertion or movement on a variety of 3-phase power tracks

IT Faretto da binario elettrificato in alluminio pressofuso; verniciatura a polvere; testata girevole 355° e orient. 90°; convertitore integrato nell'adattatore per binari elettrificati; riflettore d'alta qualità con ottica sfaccettata in alluminio applicato a vapore; curva fotometrica precisa con diversi angoli di emissione; ottima schermatura con superficie di emissione arretrata; unità ottiche come accessori; con tecnologia COB (Chip on Board) per la massima efficienza; assenza di ombre multiple; LED ad efficienza energetica con elevata resa cromatica; adattatore per installazione senza utensili o scorrimento in vari binari trifase

Quickinfo

3000K, 3500K, 4000K
CRI ≥ 90 2-SDCM
up to 87lm/W
L80 @ 50000h
non DIM, DALI-2

Types

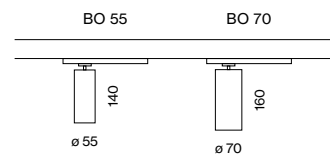

Colours



Light distributions

BO 55



spot med. flood

BO 70



spot med. flood wide flood

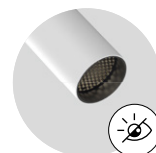

glare control via
honeycomb louver

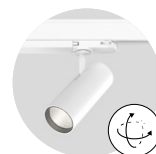

355° rotatable,
90° tiltable



CRI ≥ 90,
2 SDCM

Order options

COLOUR TEMPERATURE

3000K	5
3500K	7
4000K	6

CONTROL

non DIM	1
DALI-2	3

MATERIAL COLOUR

○ traffic white RAL 9016	7
● jet black RAL 9005	8

BEAM ANGLE BO 55

spot 17°	S
medium 24°	M
flood 40°	F

BEAM ANGLE BO 70

spot 15°	S
medium 23°	M
flood 37°	F
wide flood 57°	W

Options on request

COLOUR RENDERING INDEX

CRI ≥ 95, 2 SDCM

CONTROL

Casambi

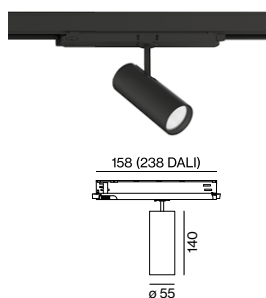

BO 55 track



TRACK LIGHT

SYSTEM POWER	LUMINOUS FLUX	ORDER CODE
24.8W	2150lm	180-7312

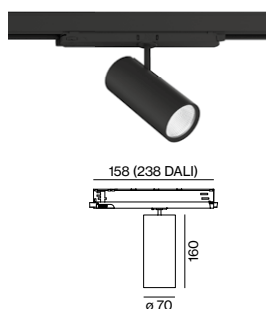

BO 70 track



TRACK LIGHT

SYSTEM POWER	LUMINOUS FLUX	ORDER CODE
40W	3410lm	180-7411

Optical accessories

HONEYCOMB LOUVER

TYPE	ØH (mm)	ORDER CODE
BO 55	50.3	007-1965598
BO 70	61.3	080-5900018



Types

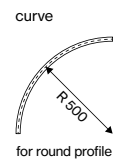
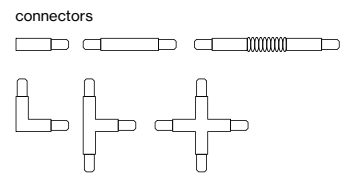
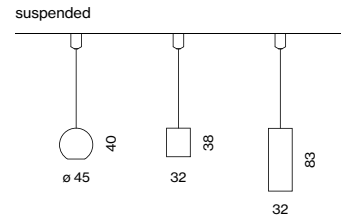
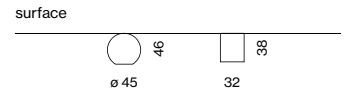
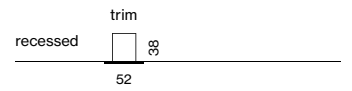

Colours



TRACK 3-phase
recessed/surface/suspended



curve connector



optimised adapter integration

TRACK recessed

Order options

CONTROL

non DIM

DALI-2

MATERIAL COLOUR

- pure white RAL 9010 7
- jet black RAL 9005 8

Pole options

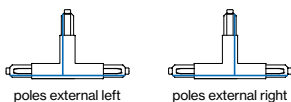
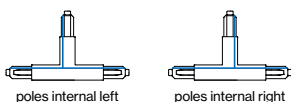

TRACK 3-phase/3-phase + DALI-2-bus



TRACK 240V-16A

L (mm)	ORDER CODE
2000	186-012213
3000	186-012313
4000	186-012413

end cap 186-022011

end feed left 186-022313
 end feed right 186-022413
 middle feed 186-021323

CONNECTORS 240V-16A

TYPE **ORDER CODE**
 linear connector 186-021113

I-connector 186-022123

L-connector right 186-022133
 L-connector left 186-022233

T-connector right (poles internal) 186-022143
 T-connector left (poles internal) 186-022243
 T-connector right (poles external) 186-022173
 T-connector left (poles external) 186-022273

X-connector 186-022153

MOUNTING ACCESSORIES

TYPE **ORDER CODE**
 clip 186-022511
 cutting tool 186-021911

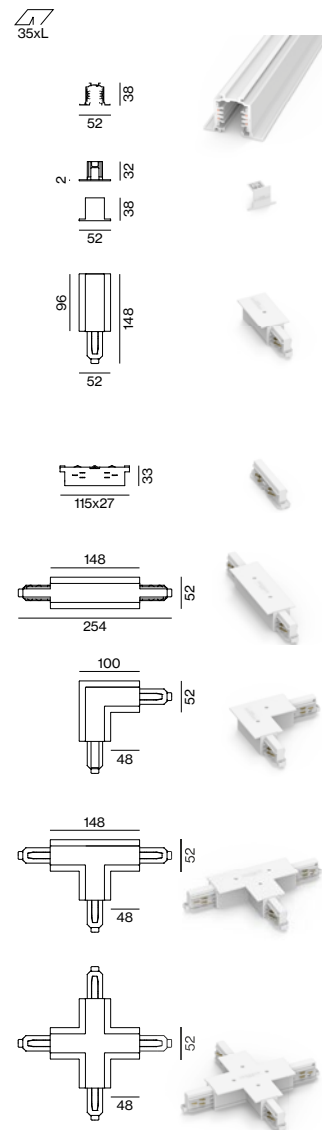

TRACK

surface/suspended

Order options

CONTROL

non DIM
 DALI-2

MATERIAL COLOUR

- pure white RAL 9010 7
- grey 6
- jet black RAL 9005 8

Pole options

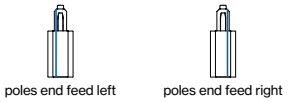
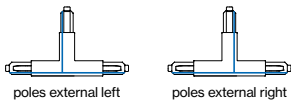
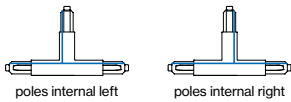

TRACK 3-phase/3-phase + DALI-2-bus



TRACK 240V-16A

L (mm)	ORDER CODE
1000	186-011123
2000	186-011223
3000	186-011323
4000	186-011423

end cap 186-021011

end feed left 186-021313
 end feed right 186-021413
 middle feed* 186-021323

*only available in white and black

CONNECTORS 240V-16A

TYPE ORDER CODE
 linear connector 186-021113

I-connector 186-021123

L-connector right 186-021133

L-connector left 186-021233

T-connector right (poles internal) 186-021143

T-connector left (poles internal) 186-021243

T-connector right (poles external) 186-021173

T-connector left (poles external) 186-021273

X-connector 186-021153

adjustable corner connector 186-021163

MOUNTING ACCESSORIES

TYPE ORDER CODE
 ceiling clip 186-021511

pendant clip cable 186-021521

pendant clip rod 186-021541

joiner piece cable 186-021531

joiner piece rod 186-021551

cutting tool 186-0219110

SUSPENSION KIT

TYPE ORDER CODE
 pendant 1000 186-021611

cable 1500 186-0217110

cable 3000 186-0217210

cable 5000 186-0217310

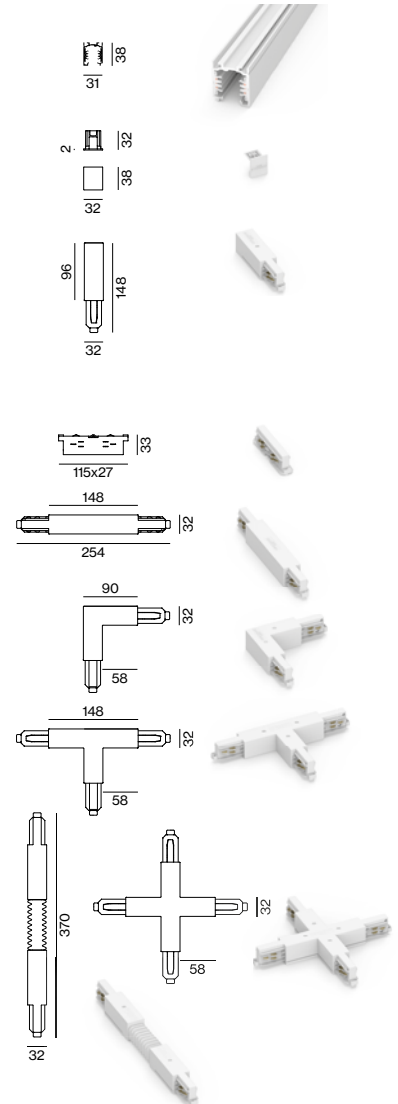

TRACK high

surface/suspended

Order options

CONTROL

non DIM

DALI-2

MATERIAL COLOUR

○ pure white RAL 9010 7

● jet black RAL 9005 8

Options on request

LIGHT OPTIC COVER

inset indirect

Pole options

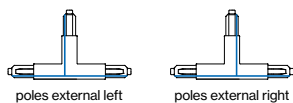
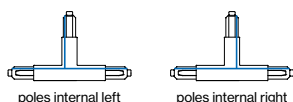

TRACK high 3-phase/3-phase + DALI-2-bus



TRACK 240V-16A

L (mm)	ORDER CODE
1000	186-016113
2000	186-016213
3000	186-016313
4000	186-016413

end cap 186-026011

end feed left 186-026313

end feed right 186-026413

middle feed 186-021323

CONNECTORS 240V-16A

TYPE **ORDER CODE**
linear connector 186-026113

I-connector 186-026123

L-connector right 186-026133

L-connector left 186-026233

T-connector right (poles internal) 186-026143

T-connector left (poles internal) 186-026243

T-connector right (poles external) 186-026173

T-connector left (poles external) 186-026273

X-connector 186-026153

MOUNTING ACCESSORIES

TYPE **ORDER CODE**
pendant clip cable 186-0265210
pendant sheet metal clip 186-0215220
pendant clip rod 186-0265410

joiner piece cable 186-0265310

joiner piece rod 186-0265510

cutting tool 186-0219110

SUSPENSION KIT

TYPE **ORDER CODE**
pendant 1000 186-0216110

cable 1500 186-0217110

cable 3000 186-0217210

cable 5000 186-0217310

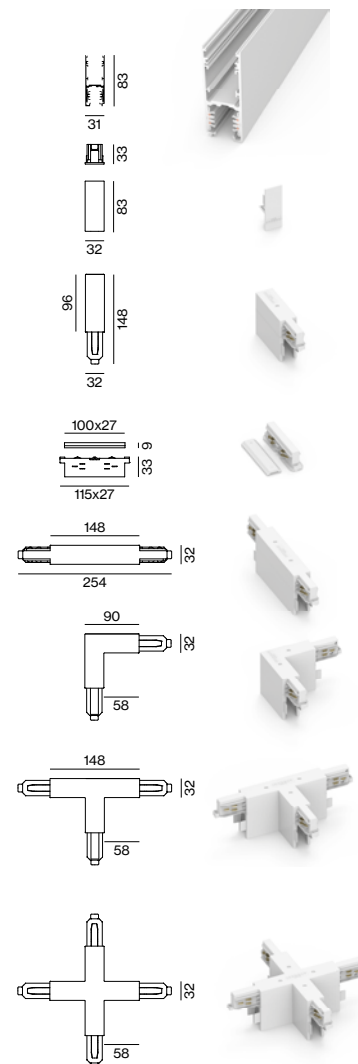

TRACK round surface/suspended

Order options

CONTROL

non DIM

DALI-2

MATERIAL COLOUR

- pure white RAL 9010 7
- jet black RAL 9005 8

Pole options

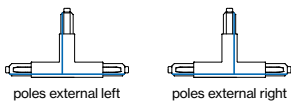
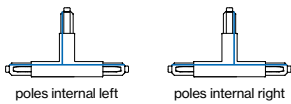

TRACK round 3-phase/3-phase + DALI-2-bus



TRACK 240V-16A

L (mm)	ORDER CODE
1000	186-015113
2000	186-015213
3000	186-015313
4000	186-015413



TRACK CURVE 240V-16A

TYPE	ORDER CODE
R 500 90° left	186-015853
R 500 90° right	186-015863

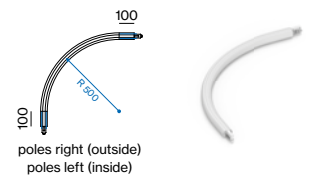

end cap 186-025011



end feed left 186-025313
 end feed right 186-025413
 middle feed 186-021323



CONNECTORS 240V-16A

linear connector 186-021113



L-connector right (external) 186-025133
 L-connector left (internal) 186-025233

T-connector left (poles external) 186-025243
 T-connector right (poles external) 186-025143
 T-connector right (poles internal) 186-025273
 T-connector left (poles internal) 186-025173

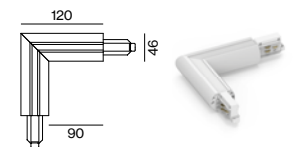

X-connector 186-025153

MOUNTING ACCESSORIES

pendant clip cable 186-025521
 pendant clip rod 186-025541

joiner piece cable 186-025531
 joiner piece rod 186-025551

cutting tool 186-0279110

SUSPENSION KIT

pendant 1000 186-021611

cable 1500 186-0217110
 cable 3000 186-0217210
 cable 5000 186-0217310